

WORKBOOK 24
Not a general catalogue



INDEX

8 SIZES INDEX

10 GUIDA ALLA CONSULTAZIONE
Consultation guide
Guide de consultation
Leseverzeichnis

252 SCHEMI DI POSA
Laying sketch
Schémas de pose
Modulverlegungsbeispiele

260 CARATTERISTICHE TECNICHE
Technical Features
Caractéristiques Techniques
Technische Eigenschaften

268 POSA E PULIZIA
Laying and cleaning
Pose et entretien
Verlegung und Reinigung

274 CONDIZIONI GENERALI DI VENDITA
General terms of sale
Conditions generales de vente
Allgemeine verkaufsbedingungen

52 Collections

B	54	BOSTON BRICKS
C	60	CHICAGO
	68	CHROMAGIC
	78	COTTO DEL CAMPIANO
D	90	DI PIETRA
F	100	FUORITONO
H	110	HAVANA
	120	HERITAGE
I	128	IN FALDA
	140	ITALICA
M	154	MATERIA PRIMA
	164	MIAMI
	174	MOLO AUDACE
N	184	NEW ORLEANS
	192	NEW YORK
R	200	REGGIO NELL'EMILIA
S	210	SHOWALL
T	230	TADELAKT
V	242	VENEZIA

Canyon teatrale

Eclettismo, creatività, immediatezza, freschezza: questa è la CIR, un moto perpetuo di ispirazioni, forme, colori, segni e materie che raffigurano e riempiono di fantasia gli spazi reali del quotidiano, ovunque, senza limiti e limitazioni. Le collezioni come piccole opere teatrali, che mettono in scena la natura interpretata attraverso il linguaggio e secondo i codici più artistici della ceramica da rivestimento, creando così infinite possibili soluzioni di design, in cui l'estetica della vita si rivela e si rinnova, atto dopo atto, in tutta la sua ricchezza di sensazioni ed emozioni. Improvvisazioni di diversi stati d'animo e differenti punti di vista che fluiscono e scorrono liberi di modellare senza fine gli spazi dell'abitare, come l'acqua del corso di un fiume o delle onde del mare scolpisce la roccia generando sempre nuovi argini o nuove scogliere.

Eclecticism, creativity, spontaneity and freshness: this is CIR, a perpetual motion of inspiration, shapes, colours, signs and materials that depict and bestow creativity in real spaces of everyday life, everywhere, without limits and limitations. The collections are like small theatrical works, which present nature interpreted through the language and in keeping with the most artistic codes of ceramic applications, thus creating countless design solutions, wherein the aesthetics of life is revealed and renewed, act after act, in all its rich sensations and emotions. Improvisations of different states of mind and different points of view that freely ebb and flow, constantly shaping living spaces, just as the water of a river or sea waves sculpts the rock, always generating new banks or new cliffs.

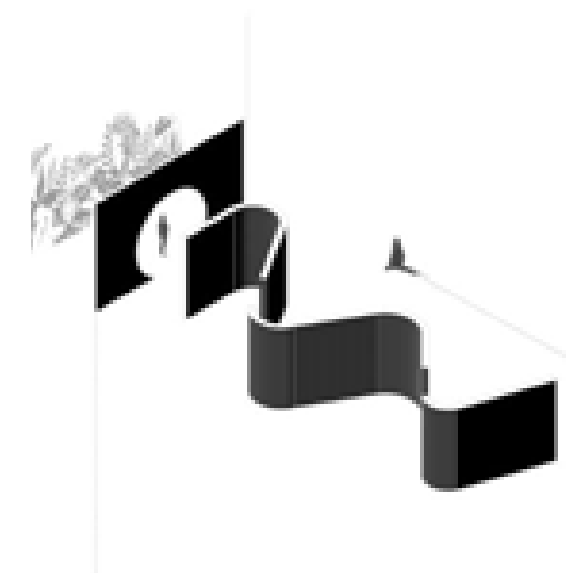

Creatività e immaginazione, libertà espressiva ed eccellenza tecnica: dalla grande sensibilità di CIR per il prodotto ceramico scaturiscono proposte ludiche e divertenti, performanti e sicure. Le collezioni CIR rendono tangibili le qualità della ceramica d'eccellenza tipicamente made in Italy: pavimenti e rivestimenti in linea con le ultime tendenze, dalle performance tecniche ed estetiche di alto valore, nel pieno rispetto dei principi di ecosostenibilità. Il costante aggiornamento stilistico e l'attività di ricerca su cromie, superfici e texture caratterizzano tutte le proposte firmate CIR, collezioni pronte a soddisfare ogni esigenza dell'abitare contemporaneo.

Creativity and imagination, expressive freedom and technical excellence: playful and amusing, high-performance and safe designs derive from CIR's great sensitivity towards ceramic products. CIR's collections are a tangible expression of top-quality Made in Italy ceramics: utterly trendy floors and walls, with high technical and aesthetic performance standards, fully compliant with environmental sustainability principles. Continuous stylistic innovation and research activities on colour, surfaces and texture are typical of all CIR's designs, collections ready to satisfy all the needs of contemporary living styles.

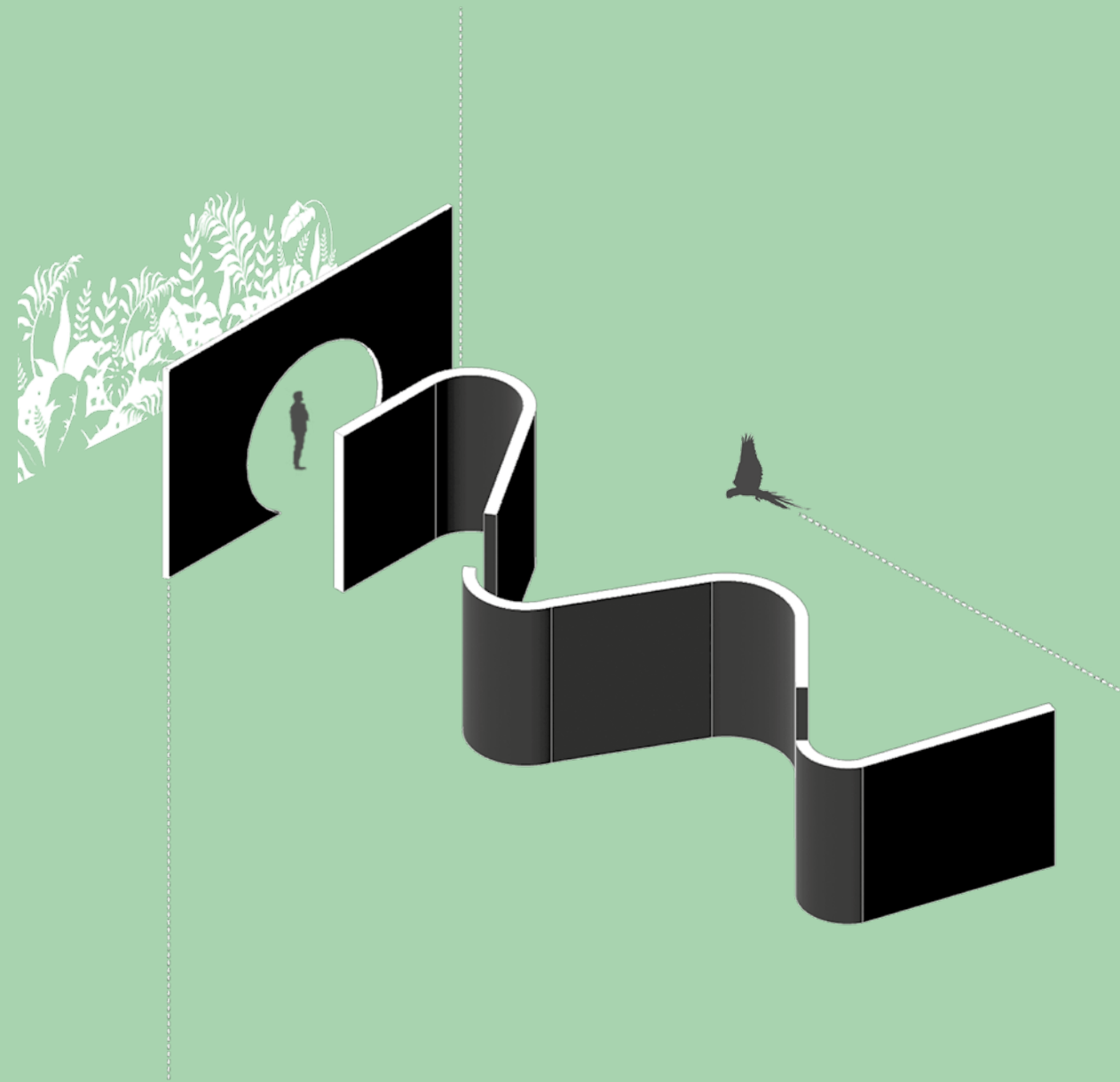



Un sistema di strumenti complementari

La documentazione di prodotto del Gruppo Romani si evolve, con l'obiettivo di **creare un sistema di strumenti di lavoro funzionali ed efficaci**, ciascuno dei quali risponde a esigenze specifiche. Nuove sinergie tra strumenti cartacei e digitali rendono immediatamente disponibili tutte le immagini e le informazioni su smartphone, tablet o computer.

A complementary tools system.

The product information provided by Gruppo Romani has been upgraded, with the aim of **creating a system of practical and effective work tools**, each one designed to meet specific requirements. New synergies between paper and digital tools enable to have an instant access to any image and information on the Smartphone, tablet or computer.

Un système d'outils complémentaires.

La documentation produit de Gruppo Romani évolue pour **créer un système d'outils de travail fonctionnels et efficaces**, chacun desquels répondant à des exigences spécifiques. De nouvelles synergies entre outils papier et outils numériques garantissent une disponibilité immédiate de toutes les images et informations sur smartphones, tablettes ou ordinateurs.

Ein System aus komplementären Hilfsmitteln.

Die Produktdokumentation von Gruppo Romani entwickelt sich weiter, mit dem Ziel der **Entwicklung eines Systems aus funktionellen und wirksamen Arbeitshilfsmitteln**, die jeweils spezifische Bedürfnisse erfüllen. Neue Synergien zwischen digitalen und Papierhilfsmitteln sorgen dafür, dass alle Bilder und Informationen sofort auf dem Smartphone, Tablet oder Computer verfügbar werden.

#productrange

Organizer 2024
Printed + digital (pdf)

#storytelling

Collection brochure
Printed + digital (pdf)

#staytuned

Digital tools

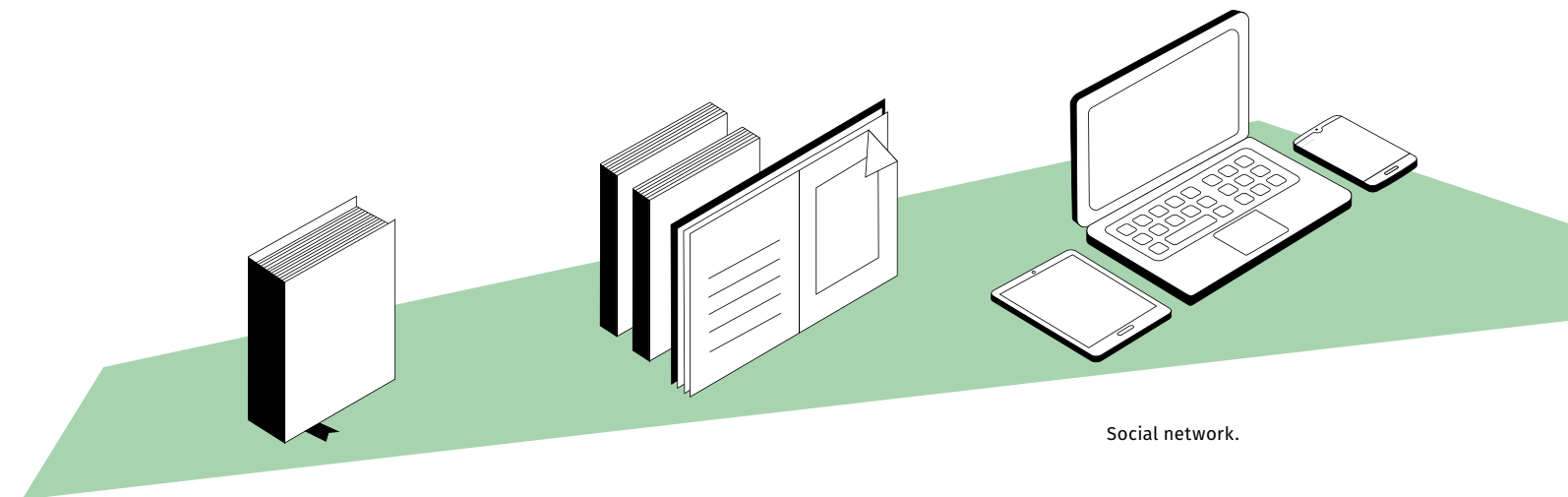

Tutte le collezioni raccolte in uno strumento agile e funzionale, con un ambiente iconico e una macro di prodotto per serie. Stampato a inizio anno e sempre disponibile in digitale, in versione aggiornata.

All the collections are stored in an agile and functional tool that displays a specific iconic setting and a product macro image for each series. It will be printed at the beginning of each year and an updated digital version will always be available.

Toutes les collections sont regroupées dans un outil flexible et fonctionnel avec une présentation iconique et une image macro du produit par série. Imprimé en début d'année et toujours disponible en version numérique mise à jour.

Alle Kollektionen zusammen in einem agilen und funktionellen Hilfsmittel, mit einem ikonischen Ambiente und einer Produkt-Makroabbildung pro Serie. Am Jahresanfang ausgedruckt und in aktualisierter Version immer digital verfügbar.

Racconto esauriente della collezione con galleria di immagini ambientate. Stampato per il lancio collezione e sempre disponibile in digitale. QRcode sull'organizer per accedere al catalogo di linea di ogni collezione.

Comprehensive presentation of the collection with a product image gallery. A printed version will be released when a collection is launched and a digital version will always be available. A QR code displayed on the organizer can be used in order to access the product line catalogue of each collection.

Récit exhaustif de la collection par le biais d'une galerie de présentations. Imprimé pour le lancement de la collection et toujours disponible en version numérique. Code QR sur l'organiseur pour accéder au catalogue de ligne de chaque collection.

Ausführliche Schilderung der Kollektion mit einer Bildergalerie von Raumgestaltungen. Ausgedruckt für die Einführung der Kollektion und immer digital verfügbar. QR-Code auf dem Organizer für den Zugriff zum Katalog der Produktlinie jeder Kollektion.

Website. Per ogni brand tutte le informazioni e le notizie.
Smart Gallery. Gallerie di immagini immediatamente sfogliabili da Smartphone
Social network. Notizie e immagini costantemente aggiornate.

Website. For viewing brand information and news.
Smart Gallery. Image galleries you can instantly browse through on the Smartphone.
Social network. Constantly updated news and images.

Website. Pour chaque marque, toutes les informations et actualités.
Smart Gallery. Galeries d'images à feuilleter immédiatement consultables sur Smartphone.
Social network. Nouvelles et images constamment mises à jour.

Website. Pro Marke alle Informationen und Nachrichten.
Smart Gallery. Bildergalerie zum sofortigen Durchblättern auf dem Smartphone.
Social network. Ständig aktualisierte Nachrichten und Bilder.



Una qualità di prodotto confermata anche da certificazioni internazionali

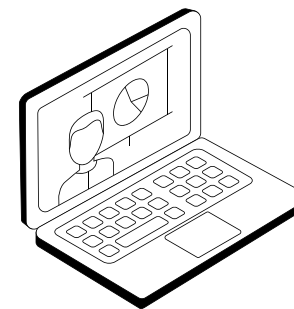
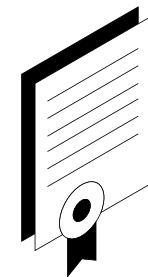

IN FALDA 128
TADELAKT 230



放射性水平A类

La qualità delle performance dei prodotti CIR è attestata da tutte le principali certificazioni internazionali, perché oltre al valore estetico riteniamo che i nostri materiali debbano rispondere ai più elevati standard in termini di funzionalità e soprattutto sicurezza d'uso in tutte le condizioni e destinazioni possibili. Questo per venire incontro ad ogni esigenza applicativa, attenti a soddisfare anche quelle specifiche che vengono richieste da determinati mercati, come indicato qui a fianco relativamente ad alcune nostre collezioni. La volontà e l'obiettivo concreto di CIR sono quelli di offrire un gres porcellanato sempre più a misura di installazione e utilizzo in ogni parte del mondo.

Product quality attested by international certifications.

The superior-quality performance of CIR products is attested by all the main international certifications because, in addition to aesthetic value, we believe that our materials must meet the highest of standards in terms of functionality and above all safety of use in every possible condition and destination. This is done to meet every application need, ensuring that specifications requested by certain markets are satisfied, as shown here alongside in relation to some of our collections. The will and concrete objective at CIR is to offer porcelain stoneware that is increasingly suitable for installation and use in every part of the world.

Une qualité du produit confirmée également par des certifications internationales.

La qualité des performances des produits CIR est attestée par toutes les principales certifications internationales, car au-delà de la valeur esthétique nous estimons que nos matériaux doivent répondre aux normes les plus élevées en termes de fonctionnalité et surtout de sécurité d'utilisation quelles que soient les conditions et les destinations. Ces caractéristiques nous permettent de satisfaire chaque exigence d'application tout en répondant aux besoins spécifiques des marchés comme indiqué ci-contre pour certaines de nos collections.

Eine Produktqualität, die auch von internationalen Zertifizierungen bestätigt wird.

Die hochwertigen Leistungen der CIR-Produkte werden von allen wichtigsten internationalen Zertifizierungen bescheinigt, denn wir sind überzeugt, dass unsere Materialien nicht nur von ästhetischem Wert sind, sondern auch den höchsten Standards in puncto Funktionalität und vor allem Gebrauchssicherheit unter allen möglichen Einsatzverhältnissen entsprechen müssen. Damit kommen wir allen Anwendungsbedürfnissen entgegen und erfüllen aufmerksam auch die spezifischen Bedürfnisse bestimmter Märkte, wie nebenan bezüglich einiger unserer Kollektionen angegeben. Der Wille und das konkrete Ziel von CIR ist es, ein Feinsteinzeug zu bieten, das immer mehr auf die Installation und Verwendung in jedem Teil der Welt angepasst ist.

GUIDA ALLA CONSULTAZIONE

Consultation guide . Guide de consultation . Leseverzeichnis

VISUALIZZA I CONTENUTI DIGITALI
Click through for digital content
Afficher les contenus numériques
Digitale Inhalte ansehen

NOME SERIE
Serie name
Nom de série
Name der Kollektion

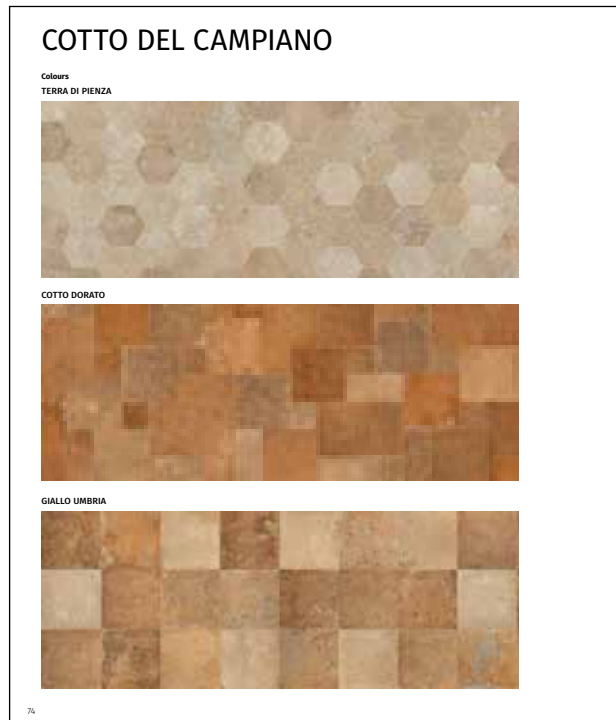
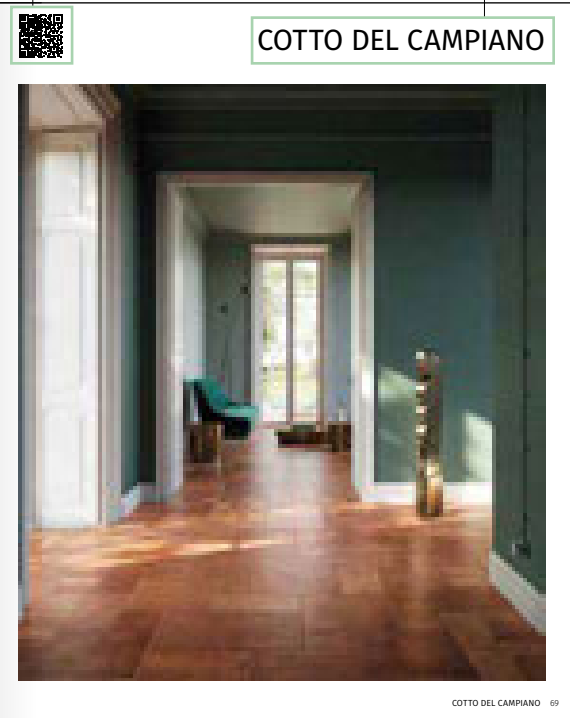

COLORI
Colours
Couleurs
Farben

10MM
3/8"
SPESORE
Thickness
Épaisseur
Stärke

PAVIMENTO
Floor tiles
Sols
Bodenfliesen

R10
CLASS B
SCIVOLOSITÀ
Skid
Glissement
Frottement

RIVESTIMENTO
Wall tiles
Murs
Wandfliesen

A+B+C
R11
SCIVOLOSITÀ
Skid
Glissement
Frottement

INGELIVO
Frost proof
Résistant au gel
Frostsicher

V2
VARIAZIONI DI TONO
Shade variations
Variations de nuance
Tonvariationen

NOME SERIE
Serie name
Nom de série
Name der Kollektion

FASCE DI PREZZO
Price ranges
Grupes des prix
Preisgruppen

FINITURE
Surface finishes
Finitions
Oberflächenfinishes

FASCE DI PREZZO
Price ranges
Grupes des prix
Preisgruppen

NAT
Naturale . Matt Finish
Naturel . Natur

A Prezzo al m²
Price x sqm
Prix / m²
Preis x qm

RETT
 Rettificato . Rectified
 Rectifié . Kalibriert

B Prezzo al pezzo
Price per piece
Prix a l'unité
Preis pro Stück

LUX-RETT
Levigato Rettificato
Polished Rectified
Poli Rectifié
Poliert Kalibriert

C Prezzo al m lineare
Price per linear metre
Prix au m linéaire
Preis pro Laufmeter

R11
Strutturato . Textured
Structuré . Strukturiert

TECNOLOGIA PRODUTTIVA
Production technology
Technologie de production
Produktionstechnologie

CARATTERISTICHE TECNICHE
Technical characteristics
Caracteristiques Techniques
Technische Eigenschaften

COTTO DEL CAMPIANO

FORMATO NOMINALE Nominal Size Format Nominal Nennformat	ARTICOLO Item Article Artikel	FASCE DI PREZZO PRICE RANGES GROUPES DES PRIX PREISGRUPPEN	BOX			PALLET		
			PEZZI Pieces Pièces Stücke	MO SqM M ² qm	KG	SCAROLE Boxes Boîtes Kartons	MO SqM M ² qm	KG
10x20 cm 4"x8"	1080478 Cotto Dorato 1080479 Giallo Umbria 1080480 Rosso Siena 1081009 Terra Di Pienza	A11	36	0,72	14,00	72	51,84	1,024
20x20 cm 8"x8"	1080481 Bianco Antico 1080482 Cotto Dorato 1080483 Giallo Umbria 1080483 Rosso Siena 1081041 Terra Di Pienza	A15 A10	26	1,04	21,00	54	56,16	1,150
20x20 cm 8"x8"	1080488 Decoro Campiano Mix (Su Bianco Antico)	A23	26	1,04	21,00	54	56,16	1,150
20x20 cm 8"x8"	1081641 Terre Emiliane Mix (Su Terra Di Pienza)	A19	26	1,04	21,00	54	56,16	1,150
20x40 cm 8"x16"	1080484 Cotto Dorato 1080485 Giallo Umbria 1080486 Rosso Siena 1081237 Terra Di Pienza	A10	13	1,04	21,00	54	56,16	1,154
20x40 cm 8"x16" R11 **	1082239 Cotto Dorato 1082240 Giallo Umbria 1082241 Rosso Siena 1082242 Terra Di Pienza	A11	13	1,04	21,00	54	56,16	1,154
ESAGONA 15,8x18,3 cm 6 1/4"x7 1/8"	1080612 Bianco Antico	A31	24	0,52	10,40	95	49,40	1,004
ESAGONA 15,8x18,3 cm 6 1/4"x7 1/8"	1080613 Cotto Dorato 1080614 Giallo Umbria 1080615 Rosso Siena 1081244 Terra Di Pienza	A26A	24	0,52	10,40	95	49,40	1,004
DECORO CAMPIANO MIX ESAGONA * 15,8x18,3 cm 6 1/4"x7 1/8"	1081301 Decoro Campiano Mix (Su Bianco Antico)	A38	24	0,52	10,40	95	49,40	1,004
TERRE EMILIANE MIX ESAGONA * 15,8x18,3 cm 6 1/4"x7 1/8"	1081302 Terre Emiliane Mix (Su Terra Di Pienza)	A38	24	0,52	10,40	95	49,40	1,004

* Soggetti miscelati casualmente nelle scatole.
Designs available with each box containing a random mix.
Modèle mélangé au hasard dans les boîtes.
Die Muster in den Schachteln werden nach dem Zufallsprinzip gemischt.

** Disponibile solo su ordinazione.
Available only on order.
Disponible uniquement sur commande.
Nur auf Bestellung erhältlich.

FORMATO NOMINALE Nominal Size Format Nominal Nennformat	ARTICOLO Item Article Artikel	FASCE DI PREZZO PRICE RANGES GROUPES DES PRIX PREISGRUPPEN	BOX			PALLET		
			PEZZI Pieces Pièces Stücke	MO SqM M ² qm	KG	SCAROLE Boxes Boîtes Kartons	MO SqM M ² qm	KG
40x40 cm 16"x16"	1080489 Cotto Dorato 1080490 Giallo Umbria 1080491 Rosso Siena 1081239 Terra Di Pienza	A10	8	1,28	26,50	48	61,44	1,288
40x60,8 cm 16"x24"	1080366 Cotto Dorato 1080367 Giallo Umbria 1080368 Rosso Siena 1081238 Terra Di Pienza	A11	4	0,97	20,00	60	58,20	1,216
40x60,8 cm 16"x24" R11	1081310 Cotto Dorato 1081311 Giallo Umbria 1081312 Rosso Siena 1081313 Terra Di Pienza	A13	4	0,97	20,00	60	58,20	1,216
MODULARE 39 ****	1080447 Cotto Dorato 1080448 Giallo Umbria 1080449 Rosso Siena 1081310 Terra Di Pienza	A20A	6	0,723	16,00	40	28,92	656

Contenuto di una scatola
One box contents
Contenu d'une boîte
Inhalt einer Schachtel

*** Decori da rivestimento ad uso residenziale interno.
Wall decorations for interior residential.
Décor mural pour usage résidentiel intérieur.
Wandfliesen nur für Innenbereich geeignet.

**** POSE MODULARE È CONSIGLIATA CON UNA FUGA DI 4-5 MM. **RECOMMEND MODULAR LAYOUT WITH A 4-5 MM JOINT.
LA POSE MODULARE EST CALCULÉE AVEC UN JOINT DE 4-5 MM. ** DIE MODULVERLEGUNG WIRD MIT EINER MINDESTFUß VON 4-5 MM EMPFOHLEN.

FORMATI/PEZZI SPECIALI/MOSAICI/DECORI
Sizes/Trims/Mosaics/Decors
Formats/Pièces spéciales/Mosaïques/Décors
Formaten/Formstücke/Mosaiken/Dekore

IMBALLAGGI
Packing
Emballages
Verpackung

CODICE ARTICOLO
Item code
Code Article
Artikelnummer



Brick

BOSTON
BRICK
54

CHICAGO
60

FUORITONO
100

HAVANA
110

NEW YORK
192

MATERIA
PRIMA
154



NEW YORK
greenwich village
192



MATERIA PRIMA
cloud white
154



FUORITONO
bianco opaco
100



MATERIA PRIMA
pink velvet
154



HAVANA
tropicana
110

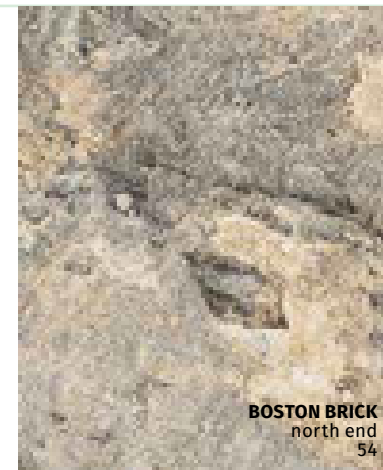

BOSTON BRICK
north end
54



BOSTON BRICK
seaport
54



MATERIA PRIMA
grey vetiver
154



FUORITONO
fuoribianco
100



HAVANA
sugar cane
110



CHICAGO
south side
60



NEW YORK
broadway
192



HAVANA
malecon
110



FUORITONO
fuoribeige
100



FUORITONO
grigio opaco
100



BOSTON BRICK
southie
54



NEW YORK
soho
192

BOSTON BRICK 54
CHICAGO 60
FUORITONO 100
HAVANA 110
NEW YORK 192
MATERIA PRIMA 154



MATERIA PRIMA
metropolitan grey
154



HAVANA
mojito
110

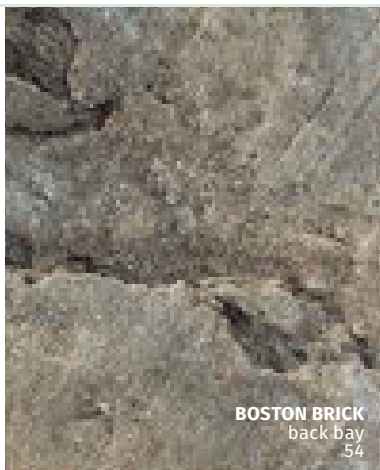

BOSTON BRICK
back bay
54



CHICAGO
old chicago
60

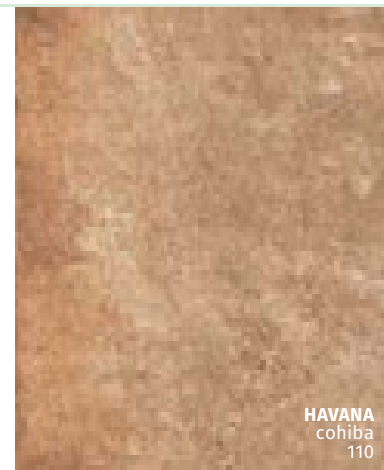

HAVANA
cohiba
110



NEW YORK
chelsea
192



NEW YORK
wall street
192



MATERIA PRIMA
soft mint
154



FUORITONO
muschio opaco
100



NEW YORK
central park
192

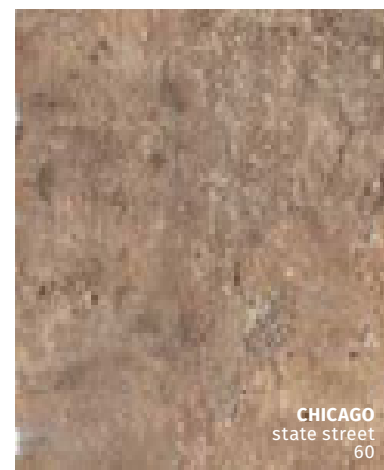

CHICAGO
state street
60



MATERIA PRIMA
jewel
154



FUORITONO
beige opaco
100



MATERIA PRIMA
hunter green
154

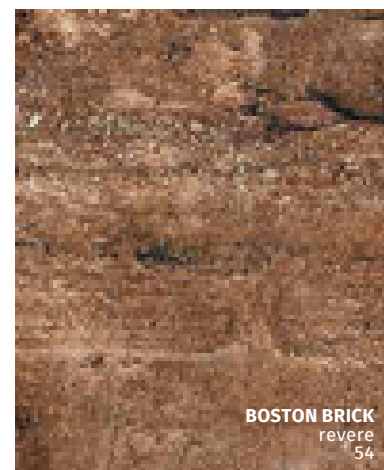

BOSTON BRICK
revere
54

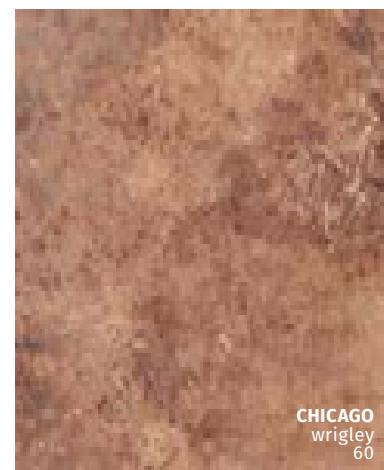

CHICAGO
wrigley
60

BOSTON
BRICK
54

CHICAGO
60

FUORITONO
100

HAVANA
110

NEW YORK
192

MATERIA
PRIMA
154

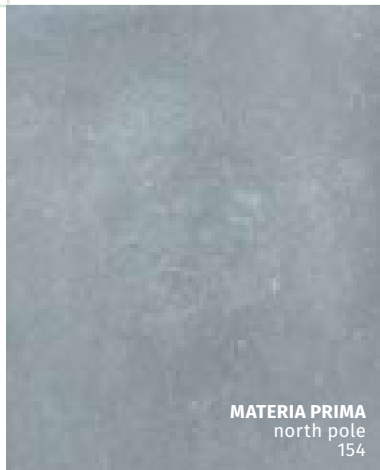

MATERIA PRIMA
north pole
154



MATERIA PRIMA
navy sea
154



HAVANA
havana sky
110



FUORITONO
petrolio opaco
100



FUORITONO
fuorimuschio
100



FUORITONO
fuorinero
100



FUORITONO
fuorigigio
100



FUORITONO
nero opaco
100



FUORITONO
fuoripetrolio
100



MATERIA PRIMA
black storm
154



Cementine

MIAMI
164
NEW ORLEANS
184
VENEZIA
242



MIAMI
white rope
164

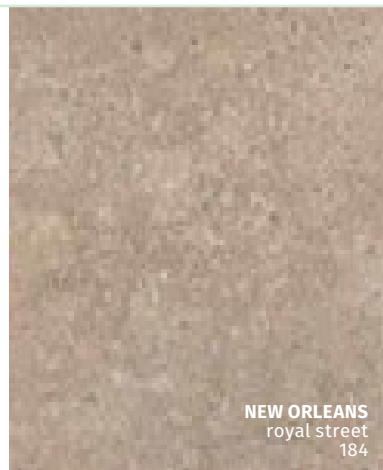

NEW ORLEANS
royal street
184



VENEZIA
grigio
142

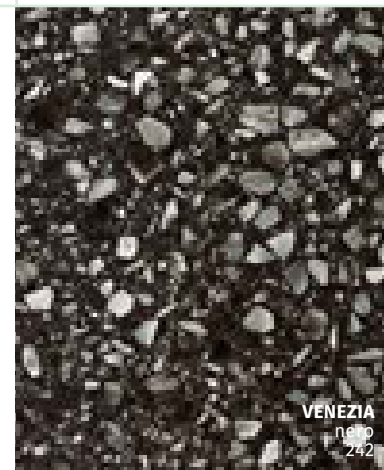

VENEZIA
nero
242



VENEZIA
blu
242



VENEZIA
bianco
242



MIAMI
light brown
164

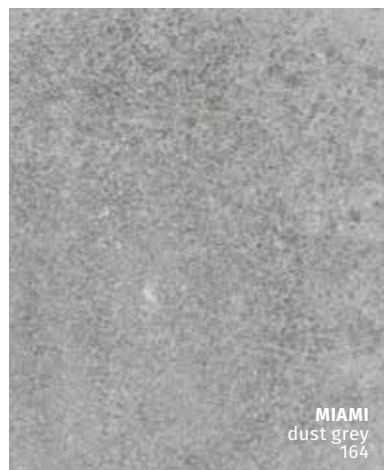

MIAMI
dust grey
164

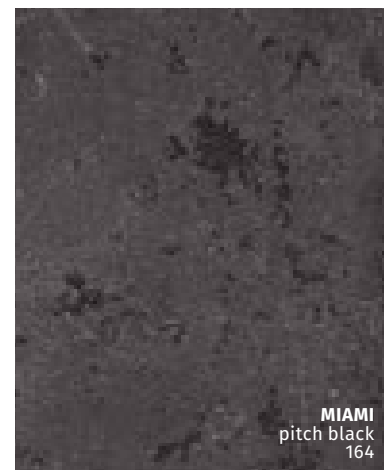

MIAMI
pitch black
164



VENEZIA
gesso
242

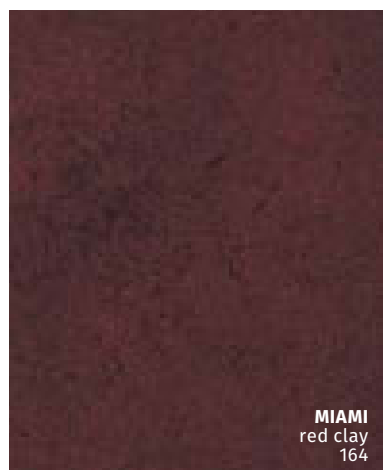

MIAMI
red clay
164



NEW ORLEANS
bourbon street
184



MIAMI
green blue
164



Cotto

COTTO DEL
CAMPIANO
78

ITALICA
140

COTTO DEL CAMPIANO
bianco antico
78

COTTO DEL CAMPIANO
terra di pienza
78

COTTO DEL CAMPIANO
cotto dorato
78

ITALICA
terra verde
140

ITALICA
terra salina
140

ITALICA
terra dolce
140

ITALICA
terra bruciata
140

ITALICA
terra blu
140

ITALICA
terra mista
140

COTTO DEL CAMPIANO
giallo umbria
78

COTTO DEL CAMPIANO
rosso siena
78

ITALICA
terra arsa
140



Pietre

DI PIETRA
90
HERITAGE
120
IN FALDA
128
MOLO AUDACE
174
REGGIO
NELL'EMILIA
200

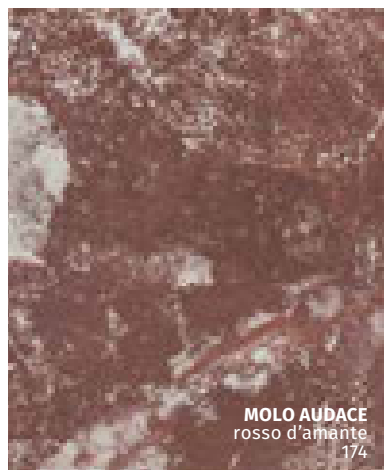
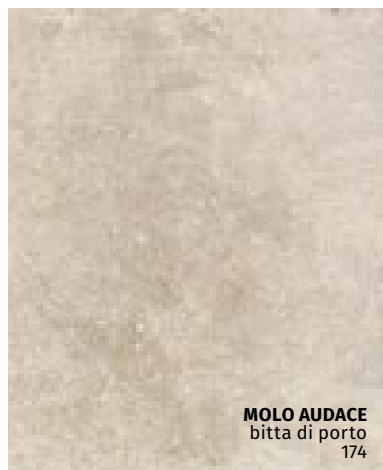
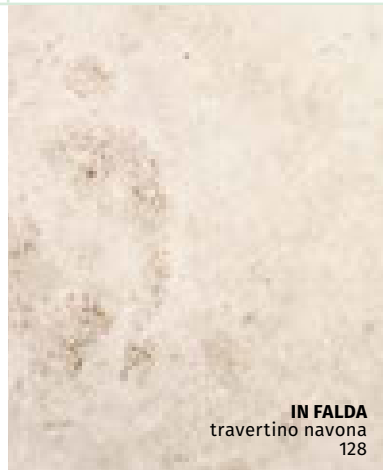

DI PIETRA
90
HERITAGE
120
IN FALDA
128
MOLO AUDACE
174
REGGIO
NELL'EMILIA
200



HERITAGE
grey
120



REGGIO NELL'EMILIA
due maestà
200



DI PIETRA
ardenne nero
90



DI PIETRA
ardenne grigio
90

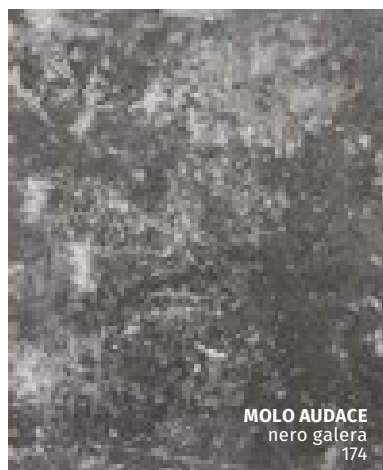

MOLO AUDACE
nero galera
174



REGGIO NELL'EMILIA
rosta nuova
200



REGGIO NELL'EMILIA
pieve
200

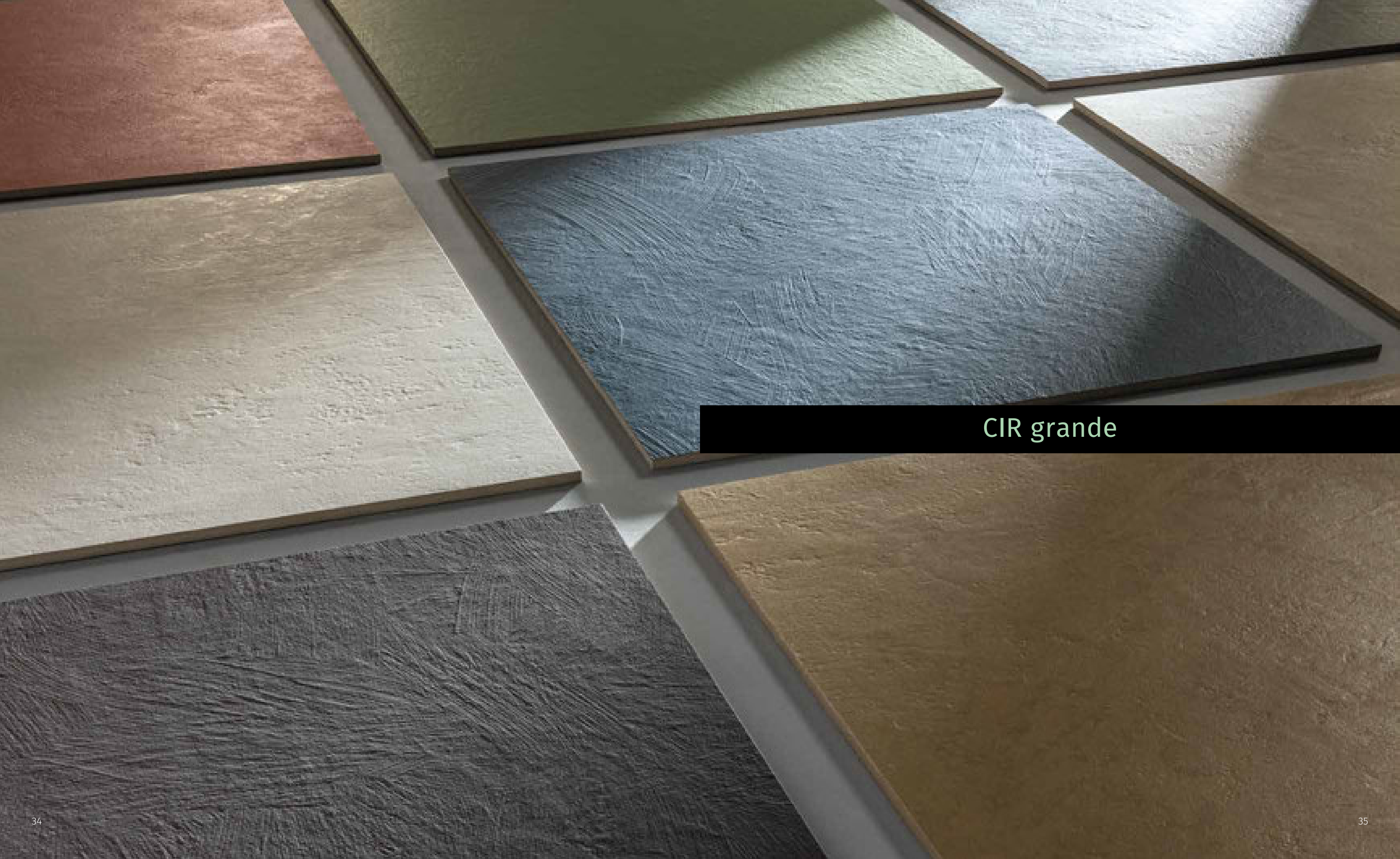

CIR grande

CHROMAGIC
68
TADELAKT
230



CHROMAGIC
tasty oyster
68



TADELAKT
kamun
230



TADELAKT
summak
230



CHROMAGIC
perfect nude
68



CHROMAGIC
green guru
68



CHROMAGIC
sage and butter
68



TADELAKT
jasmine
230



CHROMAGIC
creme caramel
68



CHROMAGIC
so chic brown
68



CHROMAGIC
forever pink
68



TADELAKT
nanà
230



CHROMAGIC
ocean surf
68



CHROMAGIC
elephant skin
68

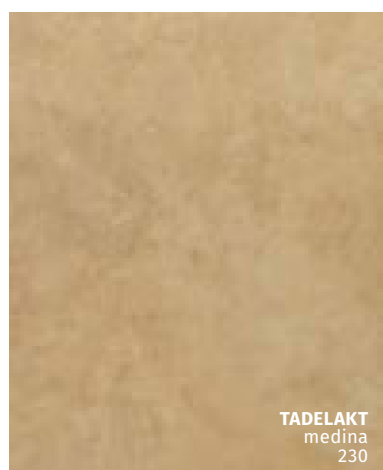

TADELAKT
medina
230



TADELAKT
atlante
230















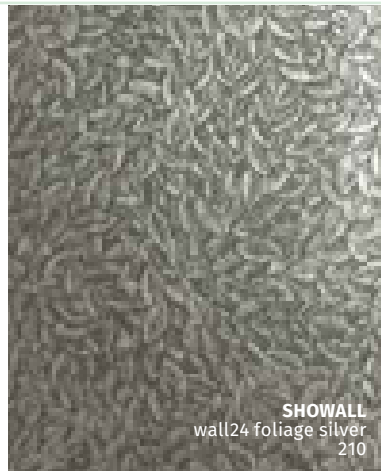
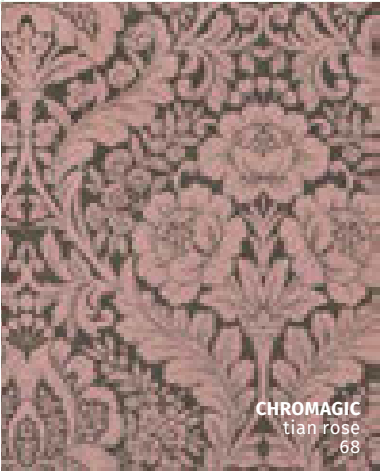
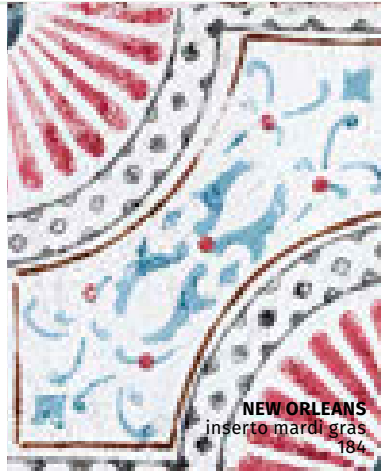

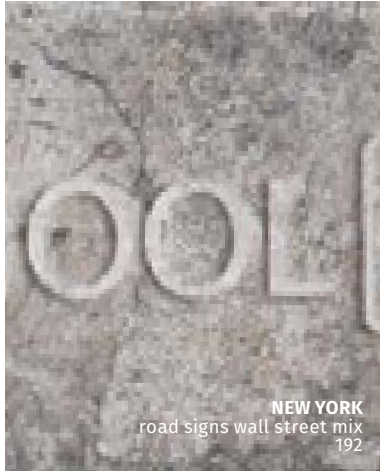
TADELAKT
berberè
230

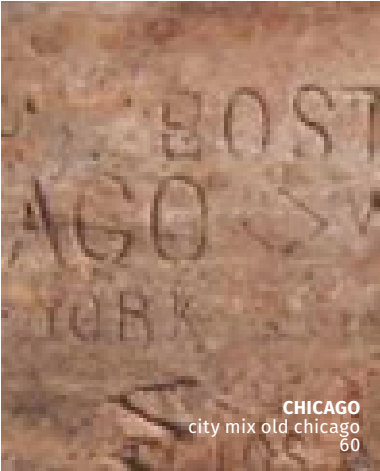

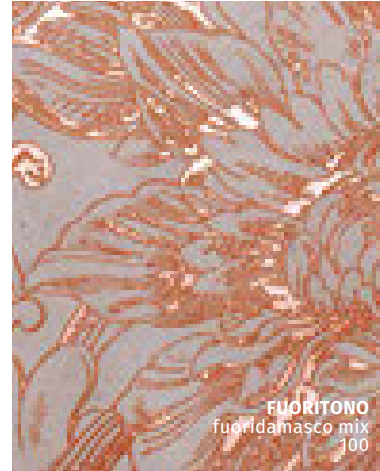
Decori

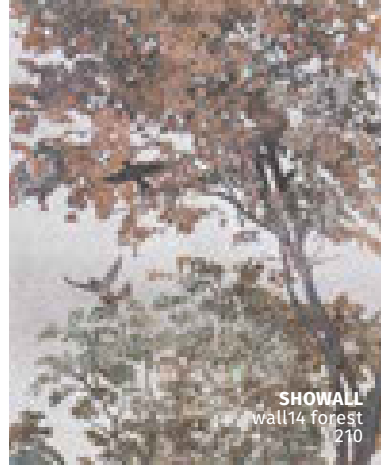

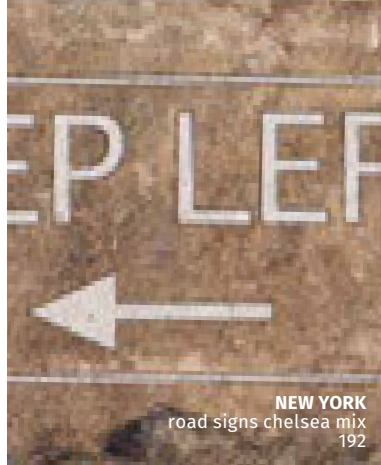







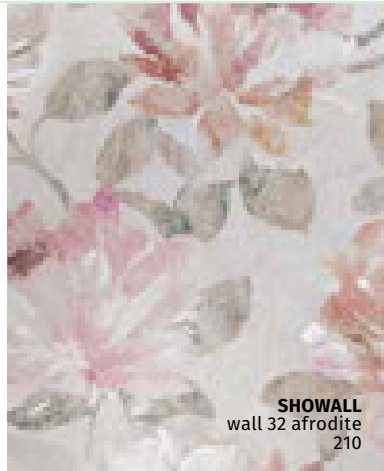
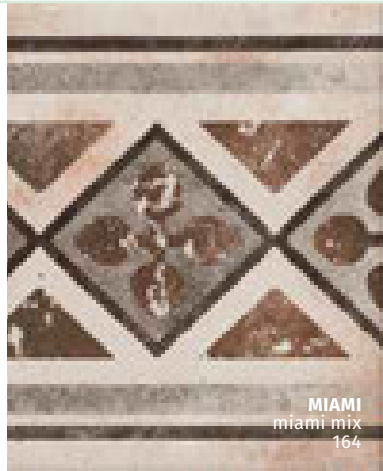

CHICAGO 60						
CHROMAGIC 68						
COTTO DEL CAMPIANO 78						
FUORITONO 100						
HAVANA 110	TADELAKT inserto majorelle mix jasmine 230	SHOWALL wall03 myfair white 210	SHOWALL wall17 palm beach 210	REGGIO NELL'EMILIA dec mix due maestà 200	SHOWALL wall33 flora avorio 210	SHOWALL wall13 fenice 210
IN FALFA 128						
ITALICA 140						
MATERIA PRIMA 154						
MIAMI 164						
MOLO AUDACE 174						
NEW ORLEANS 184	TADELAKT inserto majorelle mix kamun 230	SHOWALL wall02 myfair grey 210	SHOWALL wall10 spring 210	SHOWALL wall22 odalisca 210	REGGIO NELL'EMILIA dec mix broletto 200	NEW YORK road signs greenwich village mix 192
NEW YORK 192						
REGGIO NELL'EMILIA 200						
SHOWALL 210						
TADELAKT 230	CHICAGO city mix south side 60	TADELAKT inserto majorelle mix summak 230	COTTO DEL CAMPIANO decoro campiano 78	SHOWALL wall12 fabulous blue 210	SHOWALL wall11 fabulous pink 210	NEW YORK road signs soho mix 192
VENEZIA 242						

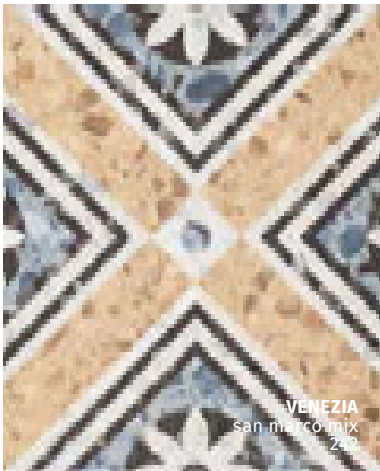
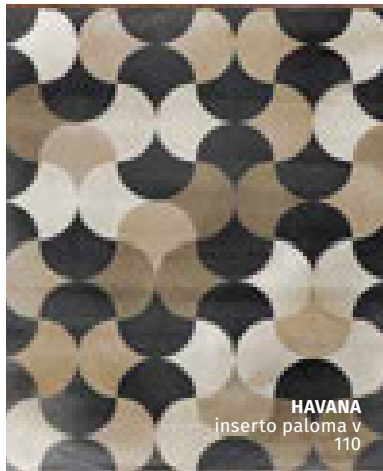
CHICAGO 60						
CHROMAGIC 68						
COTTO DEL CAMPIANO 78						
FUORITONO 100						
HAVANA 110	SHOWALL wall 30 poppy 210	SHOWALL wall 34 flora aqua 210	SHOWALL wall 24 foliage silver 210	CHROMAGIC tian rose 68	NEW ORLEANS inserto mardi gras 184	NEW YORK road signs central park mix 192
IN FALFA 128						
ITALICA 140						
MATERIA PRIMA 154						
MIAMI 164						
MOLO AUDACE 174						
NEW ORLEANS 184	REGGIO NELL'EMILIA dec mix rosta nuova 200	NEW YORK road signs wall street mix 192	HAVANA finca vigia mix 110	CHICAGO city mix old chicago 60	COTTO DEL CAMPIANO terre emiliane mix 78	FUORITONO fuori damasco mix 100
NEW YORK 192						
REGGIO NELL'EMILIA 200						
SHOWALL 210						
TADELAKT 230						
VENEZIA 242	HAVANA pilar verde 110	NEW ORLEANS french quarter royal 184	SHOWALL wall 14 forest 210	SHOWALL wall 29 pixel leaf 210	NEW YORK road signs chelsea mix 192	MIAMI collins red 164

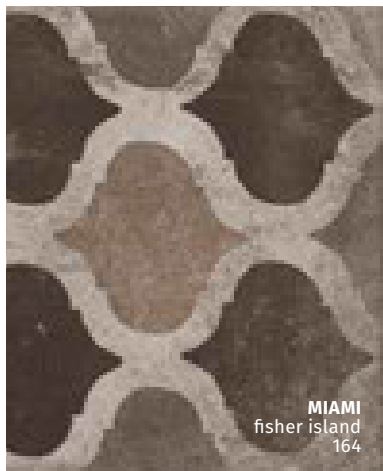
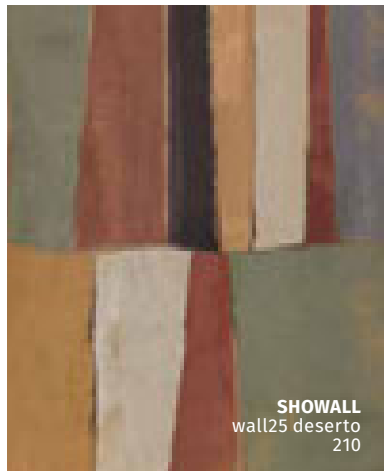
CHICAGO 60						
CHROMAGIC 68						
COTTO DEL CAMPIANO 78						
FUORITONO 100						
HAVANA 110						
IN FALFA 128						
ITALICA 140						
MATERIA PRIMA 154						
MIAMI 164						
MOLO AUDACE 174						
NEW ORLEANS 184						
NEW YORK 192						
REGGIO NELL'EMILIA 200						
SHOWALL 210						
TADELAKT 230						
VENEZIA 242						

CHICAGO 60						
CHROMAGIC 68						
COTTO DEL CAMPIANO 78						
FUORITONO 100						
HAVANA 110	MATERIA PRIMA inserto natural grey 154	COTTO DEL CAMPIANO inserto boboli 78	MATERIA PRIMA inserto natural green 154	VENEZIA cà foscarì grigio 572	FUORITONO fuorimaioica 100	CHROMAGIC herbarium emerald 68
IN FALFA 128						
ITALICA 140						
MATERIA PRIMA 154						
MIAMI 164						
MOLO AUDACE 174						
NEW ORLEANS 184						
NEW YORK 192	ITALICA terra classica blu 140	SHOWALL wall07 white leaf 210	CHROMAGIC toile de jouy olive 68	MIAMI ocean drive 164	SHOWALL wall09 jungle 210	SHOWALL wall23 foliage gold 210
REGGIO NELL'EMILIA 200						
SHOWALL 210						
TADELAKT 230						
VENEZIA 242	ITALICA terra moderna verde 140	CHROMAGIC floral olive 68		MIAMI florida blue 164	VENEZIA cà foscarì blu 242	MOLO AUDACE molo mix nero 174

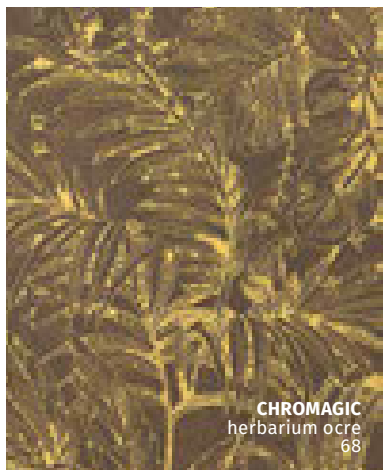
CHICAGO 60						
CHROMAGIC 68						
COTTO DEL CAMPIANO 78						
FUORITONO 100						
HAVANA 110	SHOWALL wall01 art deco 210	MIAMI coral gables 164	SHOWALL wall 32 afrodite 210	MIAMI miami mix 164	ITALICA terra moderna dolce 140	SHOWALL wall15 monkey 210
IN FALFA 128						
ITALICA 140						
MATERIA PRIMA 154						
MIAMI 164						
MOLO AUDACE 174						
NEW ORLEANS 184	VENEZIA san marco mix 210	HAVANA inserto paloma v 110	CHROMAGIC titan ocre 68	ITALICA terra nuova mix 140	MIAMI fisher island 164	SHOWALL wall25 deserto 210
NEW YORK 192						
REGGIO NELL'EMILIA 200						
SHOWALL 210						
TADELAKT 230						
VENEZIA 242	ITALICA terra moderna mista 140	MIAMI south beach 164	HAVANA cuba libre mix 110	ITALICA terra classica verde 140	CHROMAGIC herbarium ocre 68	

Collections



BOSTON BRICK

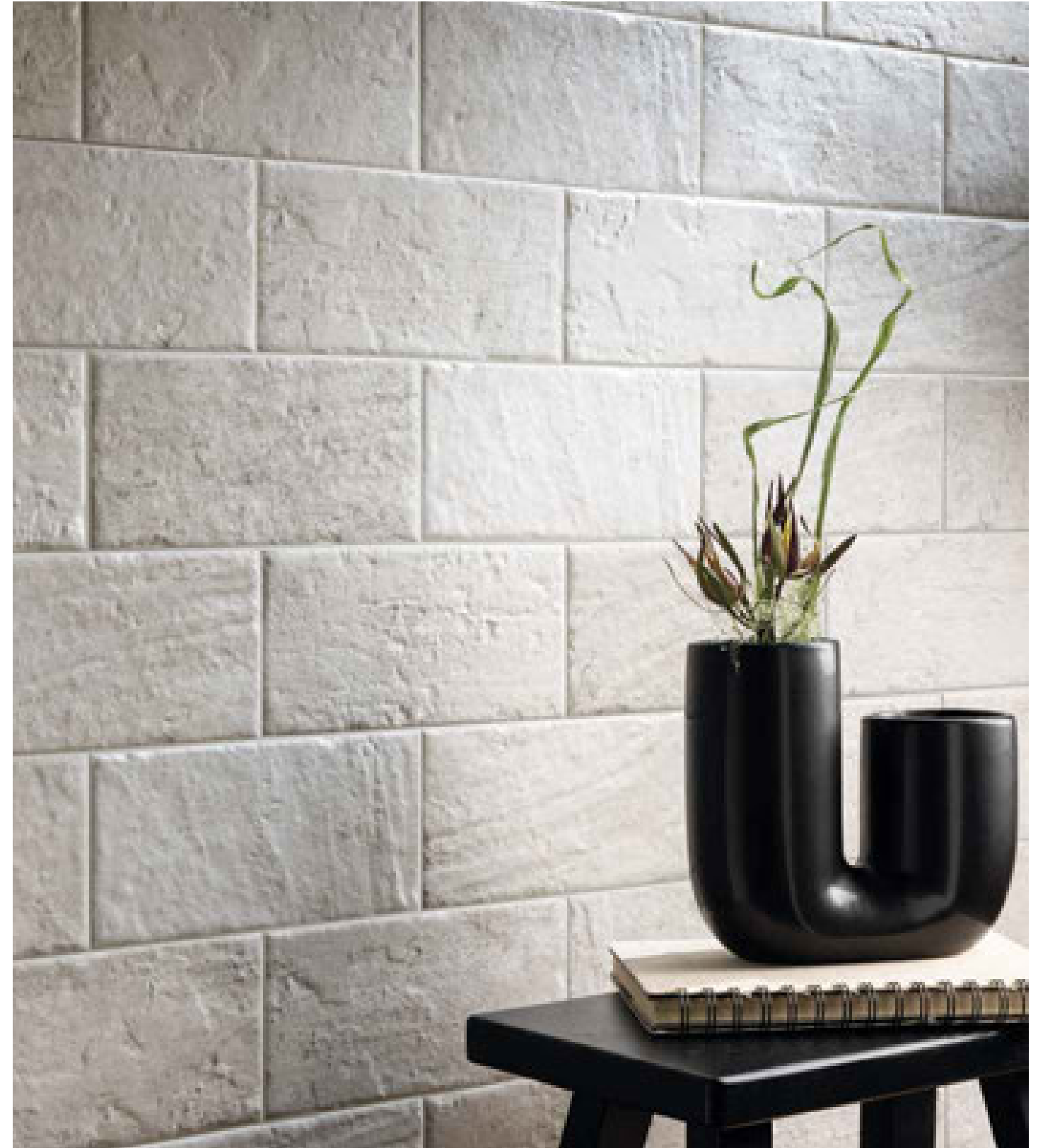



BOSTON BRICK

Colours

SEAPORT



SOUTHIE



BACK BAY



Gres fine porcellanato smaltato

Glazed fine porcelain stoneware . Grès cérame fin émaillé . Glasiertes Feinsteinzeug



REVERE



NORTH END



FORMATO NOMINALE Nominal Size Format Nominal Nennformat	ARTICOLO Item Article Artikel	FASCE DI PREZZO Price ranges Groupes des prix Preisgruppen	BOX			PALLET		
			PEZZI Pièces Pièces Stücke	MQ Sqm Mc Qm	KG	SCATOLE Boxes Boîtes Kartons	MQ Sqm Mc Qm	KG
 10x20 cm 4"x8"	1085375 Back Bay 1085376 North End 1085377 Revere 1085378 Seaport 1085379 Southie	A11	36	0,72	14,00	72	51,84	1.024
 ESAGONA 15,8x18,3 6 ¹ / ₄ "x7 ³ / ₁₆ "	1085370 Esagona Back Bay 1085371 Esagona North End 1085372 Esagona Revere 1085373 Esagona Seaport 1085374 Esagona Southie	A26A	24	0,52	10,40	95	49,40	1.004



CHICAGO

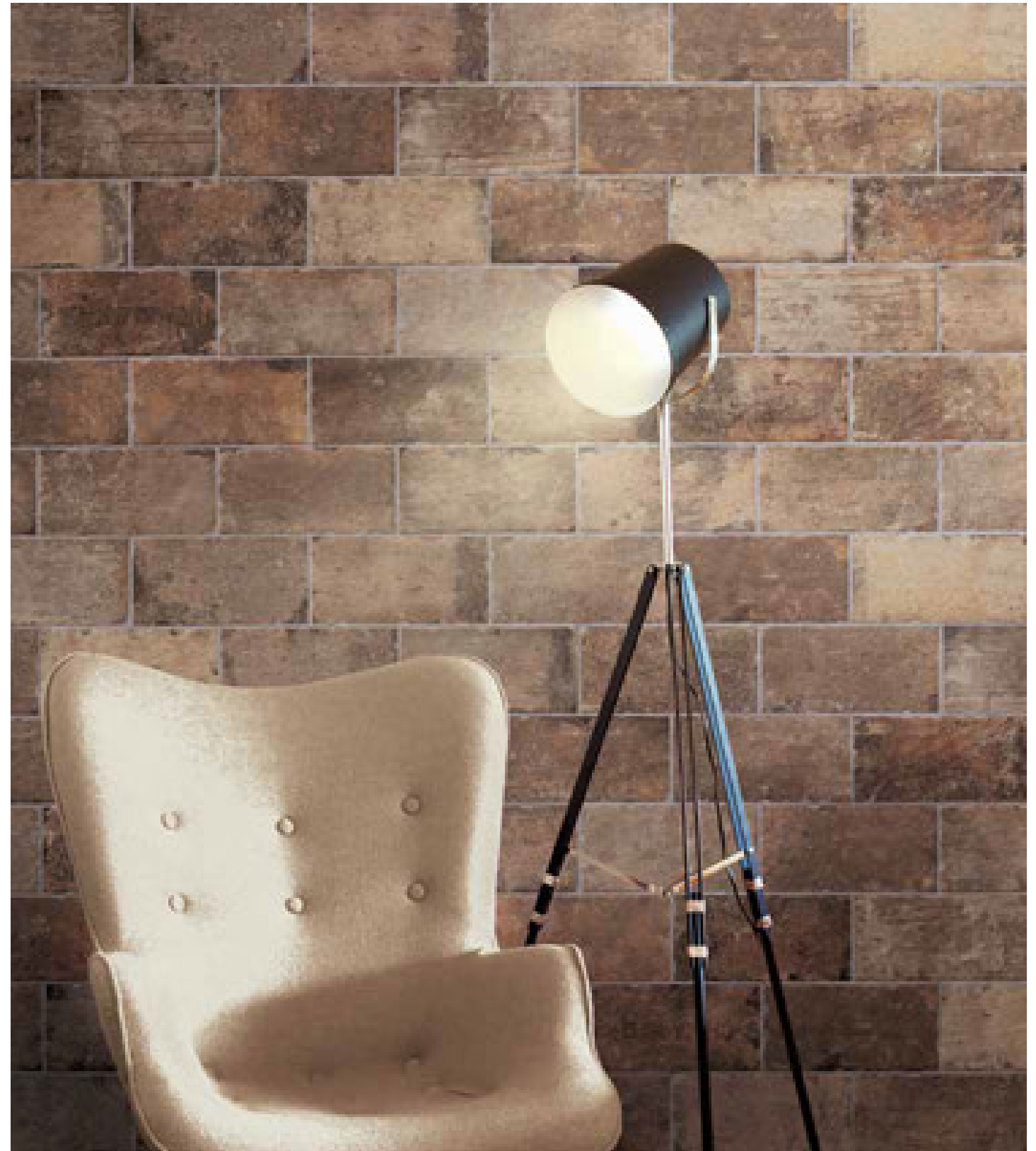

Old Chicago 10x20
Old Chicago XL 20x40 R11



CHICAGO

Colours

OLD CHICAGO *

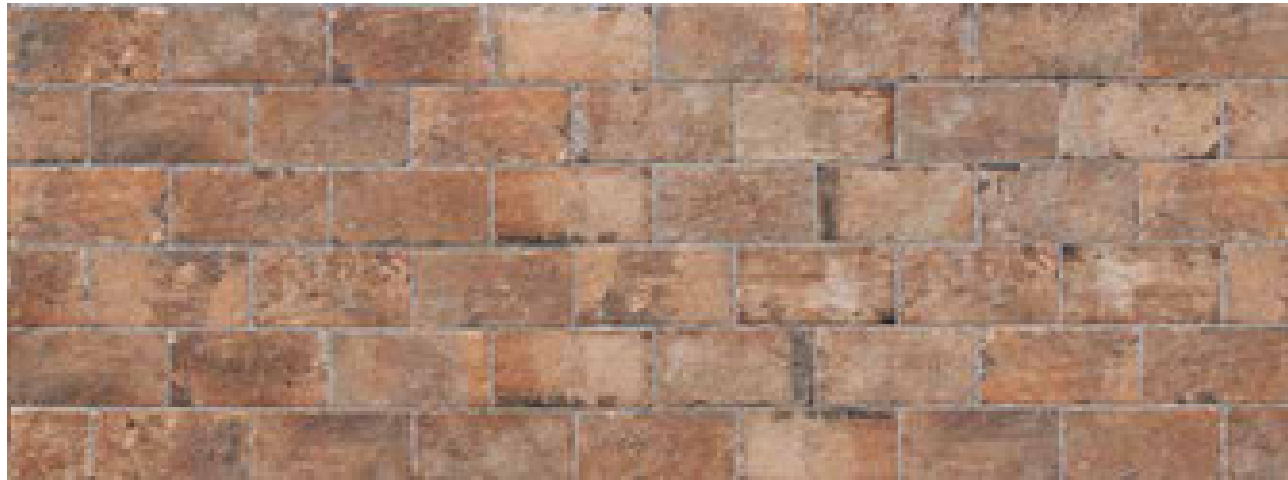

SOUTH SIDE *



STATE STREET *



* **All'interno di ogni scatola ci sono 2-3 pezzi con la scritta Chicago Brick.** 0-3 varied, imprinted Chicago Brick pieces included in every box.
A l'intérieur de chaque boîte, il y a 2/3 pièces avec l'écrit Chicago Brick. Innerhalb jede karton gibt es 2-3 stück mit der aufschrift Chicago Brick.

Gres fine porcellanato smaltato

Glazed fine porcelain stoneware . Grès cérame fin émaillé . Glasiertes Feinsteinzeug



WRIGLEY *



CITY MIX OLD CHICAGO **









CITY MIX SOUTH SIDE**



** **26 soggetti miscelati casualmente nelle scatole.** 26 designs available with each box containing a random mix.
26 motifs mélangés au hasard dans les boîtes. Die 26 Muster in den Schachteln werden nach den Zufallsprinzip gemischt.

CHICAGO

FORMATO NOMINALE Nominal Size Format Nominal Nennformat	ARTICOLO Item Article Artikel	FASCE DI PREZZO Price Ranges Groupes Des Prix Preisgruppen	BOX			PALLET		
			PEZZI Pieces Pièces Stücke	MQ Sqm Mc Qm	KG	SCATOLE Boxes Boîtes Kartons	MQ Sqm Mc Qm	KG
 10x20 cm* 4"x8"	1047364 Old Chicago 1047365 South Side 1047367 State Street 1047368 Wrigley	A11	34	0,68	14,30	72	48,96	1.046
 CITY MIX** 10x20 cm 4"x8"	1047422 City Mix Old Chicago 1047423 City Mix South Side	A20A	34	0,68	14,30	72	48,96	1.046
 ESAGONA 24x27,7 cm 9 7/16"x10 7/8"	1047370 Esagona Old Chicago 1047371 Esagona South Side 1047390 Esagona State Street 1047391 Esagona Wrigley	A19	20	0,97	20,50	56	54,32	1.164
 20x20 cm 8"x8"	1048196 Old Chicago L 1048197 South Side L	A10	24	0,96	21,00	54	51,84	1.150
 20x40 cm 8"x16"	1048186 Old Chicago XL 1048187 South Side XL	A10	12	0,96	21,10	54	51,84	1.156
 20x40 cm 8"x16" R11	1048686 Old Chicago XL R11 1048687 South Side XL R11	A11	12	0,96	21,10	54	51,84	1.156
 40x40 cm 16"x16"	1048678 Old Chicago XXL 1048679 South Side XXL	A10	8	1,28	26,50	48	61,44	1.288



* All'interno di ogni scatola ci sono 2-3 pezzi con la scritta Chicago Brick.
0-3 varied, imprinted Chicago Brick pieces included in every box.
A l'intérieur de chaque boîte, il y a 2/3 pièces avec l'écrit Chicago Brick.
Innerhalb jede karton gibt es 2-3 stück mit der aufschrift Chicago Brick.

** 26 soggetti miscelati casualmente nelle scatole.
26 designs available with each box containing a random mix.
26 motifs mélangés au hasard dans les boîtes.
Die 26 Muster in den Schachteln werden nach den Zufallsprinzip gemischt.

Gres fine porcellanato smaltato

Glazed fine porcelain stoneware . Grès cérame fin émaillé . Glasiertes Feinsteinzeug



FORMATO NOMINALE Nominal Size Format Nominal Nennformat	ARTICOLO Item Article Artikel	FASCE DI PREZZO Price Ranges Groupes Des Prix Preisgruppen	BOX			PALLET		
			PEZZI Pieces Pièces Stücke	MQ Sqm Mc Qm	KG	SCATOLE Boxes Boîtes Kartons	MQ Sqm Mc Qm	KG
 MOSAICO SPACCO 30x40 cm 12"x16" 7,5x7,5 cm 3"x3"	1048268 Old Chicago 1048269 South Side 1048270 State Street 1048271 Wrigley	B16	5	0,60	13,00			
 BATTISCOPA 6,5x40 cm 2 9/16"x16"	1050080 Old Chicago 1050105 South Side	C3	20	ml 8,00	11,00			
 ELEMENTO AD "L" MONOLITICO R11 10x40x4 cm 4"x16"x1 9/16"	1049291 Old Chicago 1049292 South Side 1049293 State Street	B24	8		9,20			



South Side 10x20
City Mix South Side 10x20



CHROMAGIC



So Chic Brown 60x120 rett.
Forever Pink 60x120 rett.
Fascia Tian Rose 30x60 rett.
Perfect Nude 60x120 rett.



CHROMAGIC

Colours

TASTY OYSTER

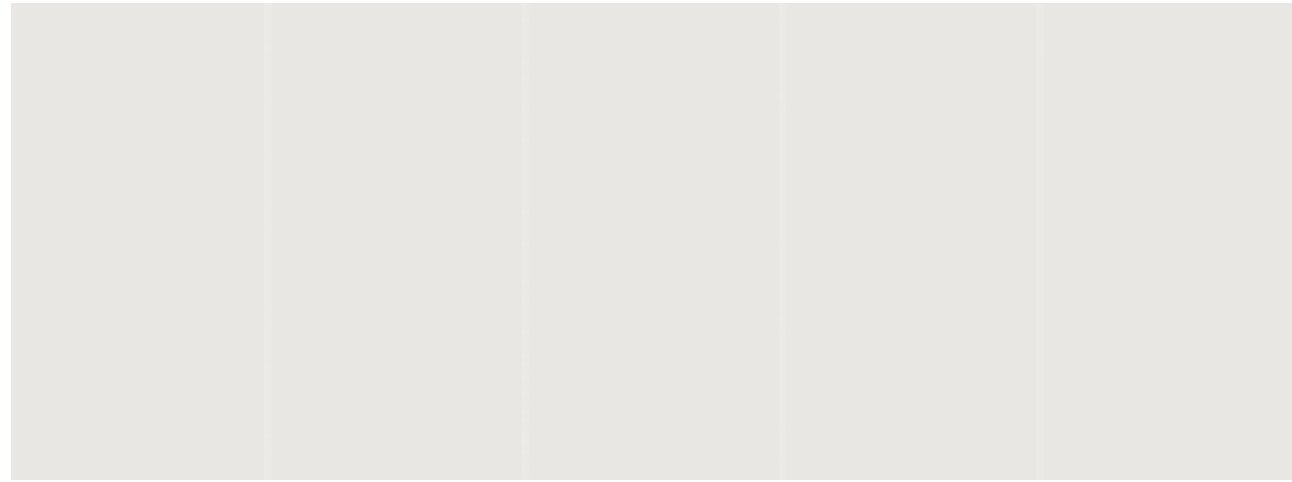

ELEPHANT SKIN

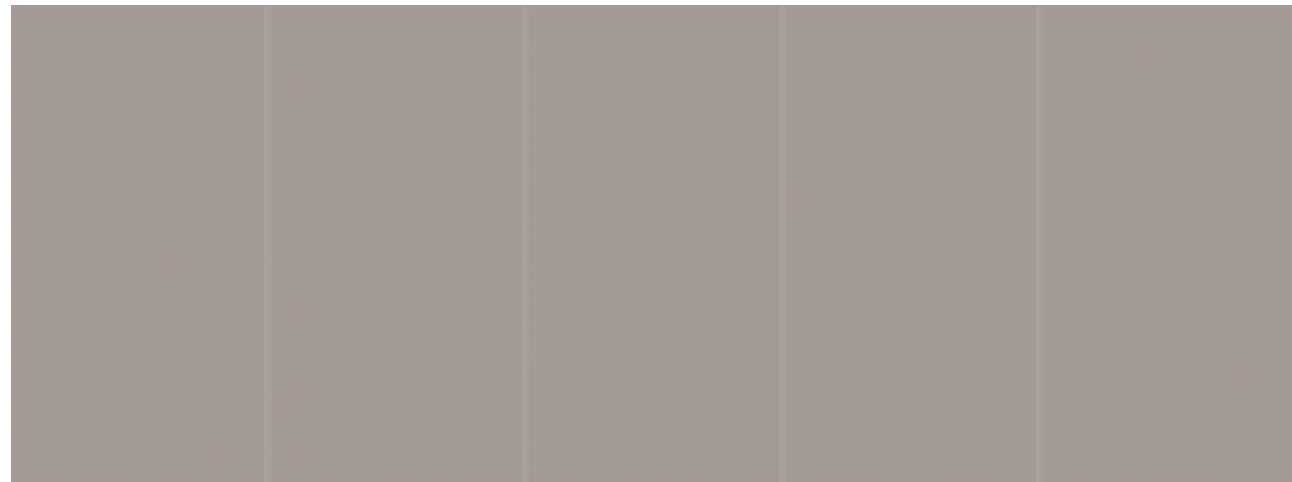

OCEAN SURF

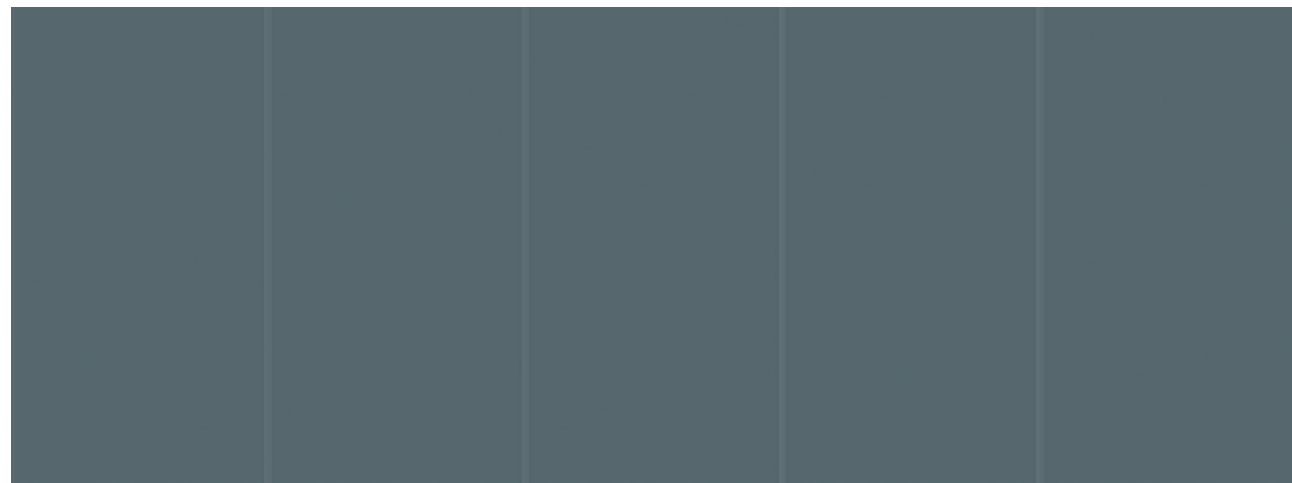

Gres fine porcellanato smaltato

Glazed fine porcelain stoneware . Grès cérame fin émaillé . Glasiertes Feinsteinzeug



PERFECT NUDE

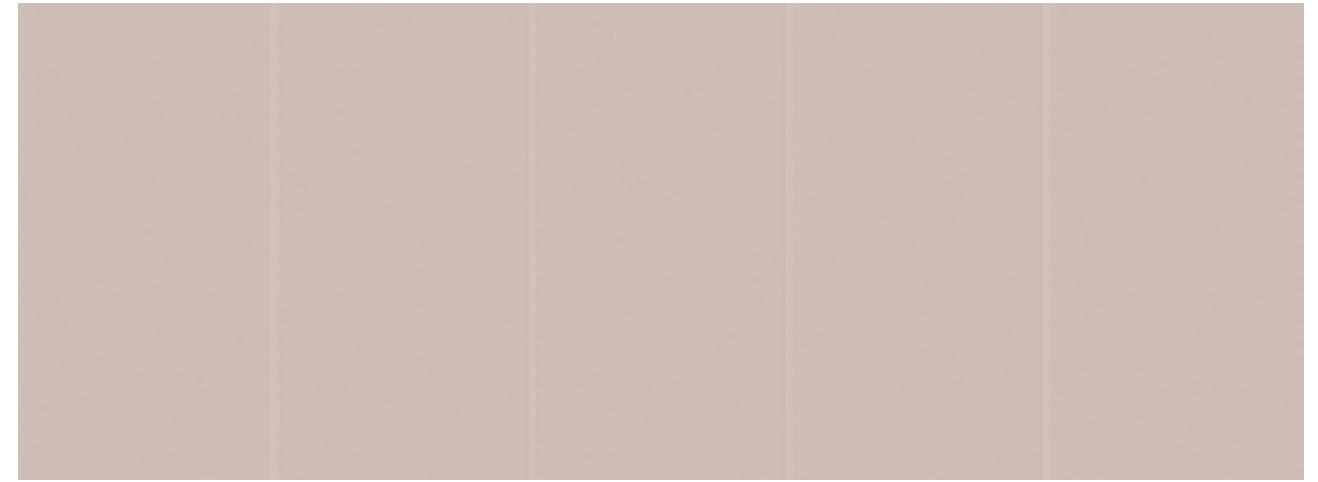

FOREVER PINK

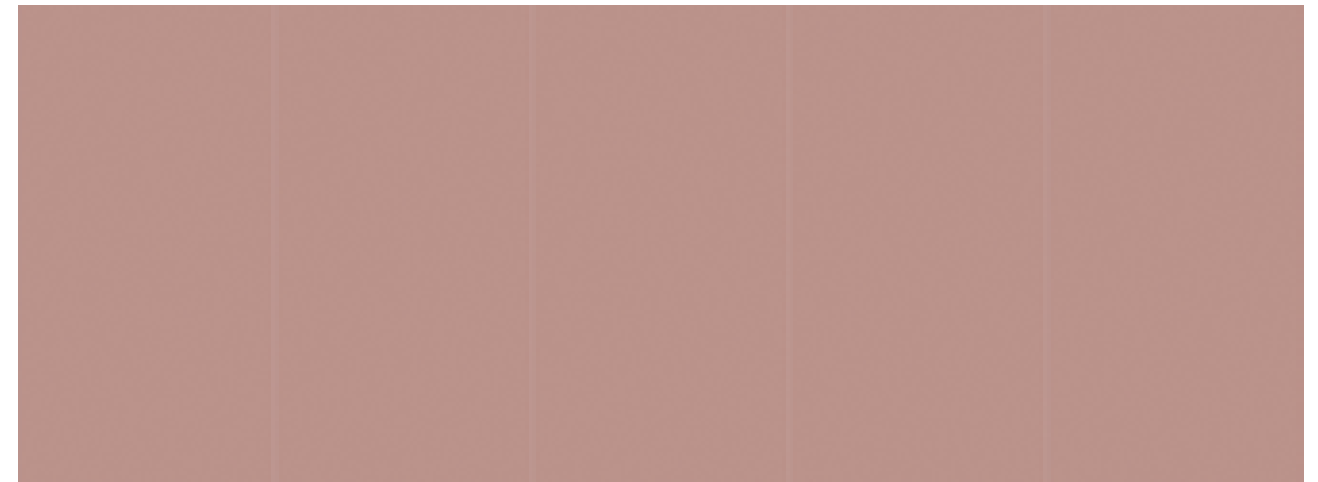

GREEN GURU



CHROMAGIC

Colours

SAGE AND BUTTER



SO CHIC BROWN

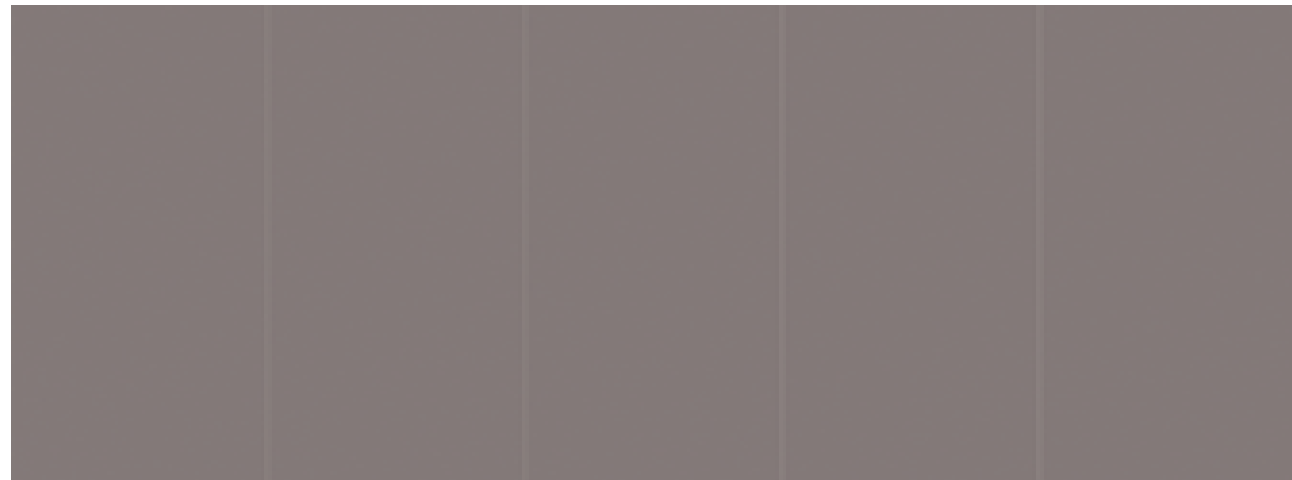

CREME CARAMEL

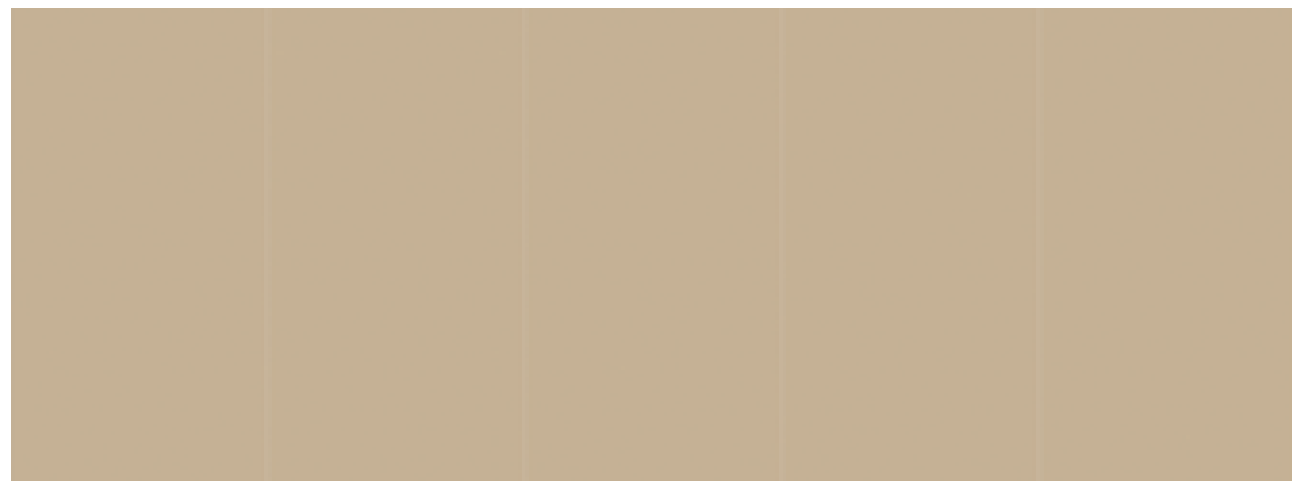



Gres fine porcellanato smaltato

Glazed fine porcelain stoneware . Grès cérame fin émaillé . Glasiertes Feinsteinzeug

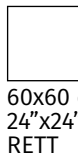

Floral Olive 60x120 rett
Sage and Butter 60x120 rett
Tasty Oyster 60x120 rett

CHROMAGIC

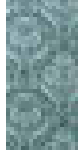
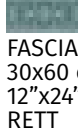
FORMATO NOMINALE Nominal Size Format Nominal Nennformat	ARTICOLO Item Article Artikel	FASCE DI PREZZO Price Ranges Groupes Des Prix Preisgruppen	BOX			PALLET		
			PEZZI Pieces Pièces Stücke	MQ Sqm Mc Qm	KG	SCATOLE Boxes Boîtes Kartons	MQ Sqm Mc Qm	KG
 60x120 cm 24"x48" RETT	1074141 Creme Caramel 1074142 Elephant Skin 1074143 Forever Pink 1074144 Green Guru 1074145 Ocean Surf 1074146 Perfect Nude 1074147 Sage And Butter 1074148 So Chic Brown 1074149 Tasty Oyster	A29	2	1,44	31,00	36	51,84	1.144
 60x60 cm 24"x24" RETT	1075310 Creme Caramel 1075311 Elephant Skin 1075312 Forever Pink 1075313 Green Guru 1075314 Ocean Surf 1075315 Perfect Nude 1075316 Sage And Butter 1075317 So Chic Brown 1075318 Tasty Oyster	A17	3	1,08	22,80	40	43,20	928
 FLORAL * 60x120 cm 24"x48" RETT	1074171 Floral Blue 1074172 Floral Bordeaux 1074173 Floral Olive	B63	2	1,44	31,00			
 HERBARIUM * 60x120 cm 24"x48" RETT	1074170 Herbarium Emerald 1074169 Herbarium Ocre	B62D	2	1,44	31,00			
 TIAN * 60x120 cm 24"x48" RETT	1074166 Tian Emerald 1074157 Tian Ocre 1074159 Tian Rose	B62C	2	1,44	31,00			
 FASCIA TIAN * 30x60 cm 12"x24" RETT	1074987 Fascia Tian Emerald 1074988 Fascia Tian Ocre 1074989 Fascia Tian Rose	B36	4	0,72	15,20			

Gres fine porcellanato smaltato

Glazed fine porcelain stoneware . Grès cérame fin émaillé . Glasiertes Feinsteinzeug



FORMATO NOMINALE Nominal Size Format Nominal Nennformat	ARTICOLO Item Article Artikel	FASCE DI PREZZO Price Ranges Groupes Des Prix Preisgruppen	BOX			PALLET		
			PEZZI Pieces Pièces Stücke	MQ Sqm Mc Qm	KG	SCATOLE Boxes Boîtes Kartons	MQ Sqm Mc Qm	KG
 TOILE DE JOUY * 60x120 cm 24"x48" RETT	1074154 Toile de Jouy Bordeaux 1074155 Toile de Jouy Olive	B62C	2	1,44	31,00			
 FASCIA TOILE DE JOUY * 30x60 cm 12"x24" RETT	1074985 Fascia Toile de Jouy Bordeaux 1074986 Fascia Toile de Jouy Olive	B36	4	0,72	15,20			



* Decori da rivestimento ad uso residenziale interno.

Wall decorations for interior residential.
Décor mural pour usage résidentiel intérieur.
Wanddekore nur für Innenbereich geeignet.



COTTO DEL CAMPIANO

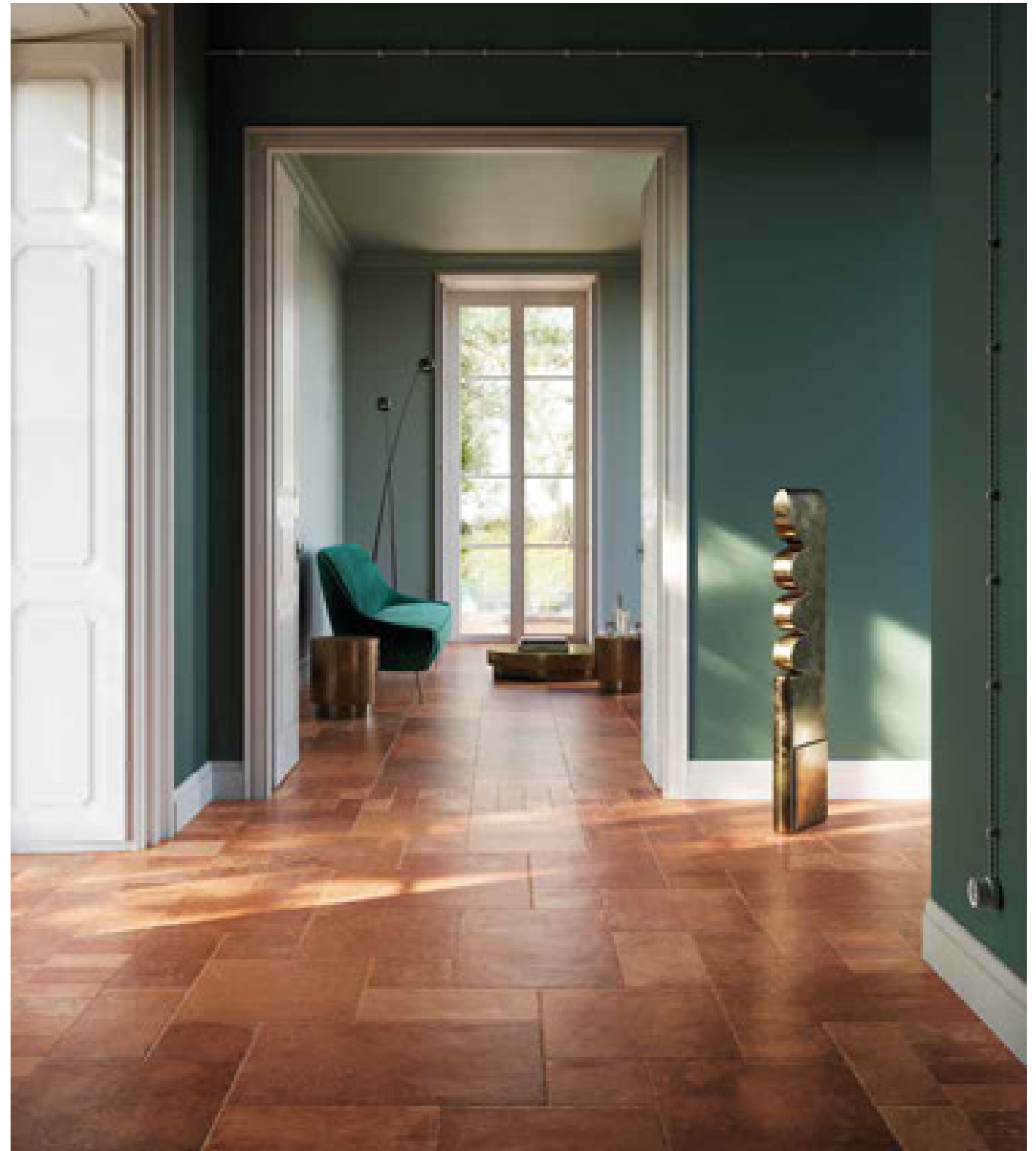



COTTO DEL CAMPIANO

Colours

TERRA DI PIENZA



COTTO DORATO



GIALLO UMBRIA



Gres fine porcellanato smaltato

Glazed fine porcelain stoneware . Grès cérame fin émaillé . Glasiertes Feinsteinzeug



ROSSO SIENA

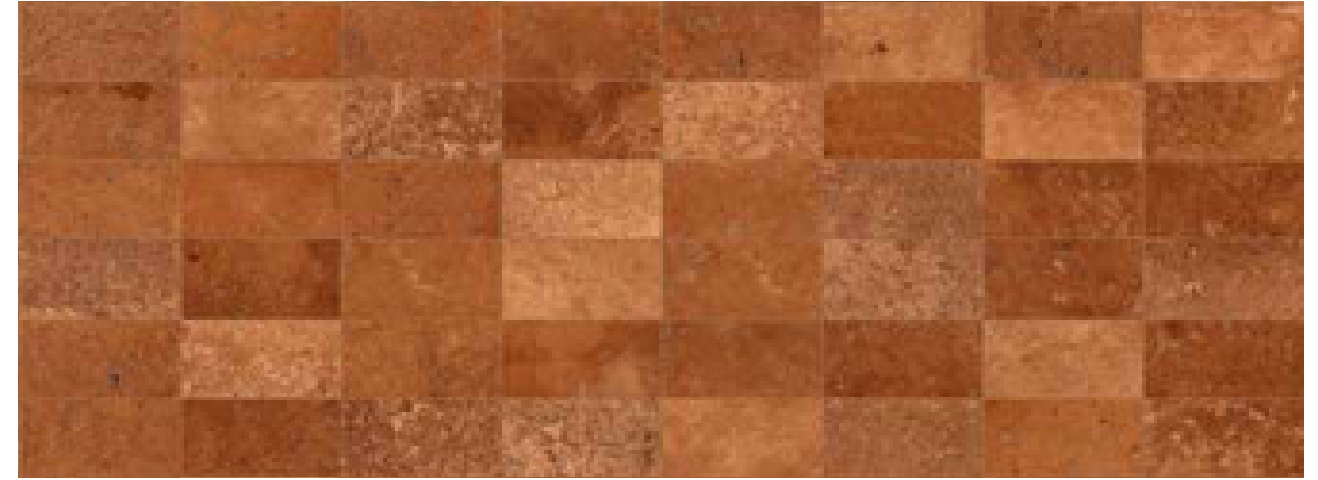

BIANCO ANTICO



COTTO DEL CAMPIANO

Colours

DECORO CAMPIANO MIX *



TERRE EMILIANE MIX **



* 15 soggetti miscelati casualmente nelle scatole.
15 designs available with each box containing a random mix.
15 motifs mélangés au hasard dans les boîtes.
Die 15 Muster in den Schachteln werden nach den Zufallsprinzip gemischt.

** 24 soggetti miscelati casualmente nelle scatole.
24 designs available with each box containing a random mix.
24 motifs mélangés au hasard dans les boîtes.
Die 24 Muster in den Schachteln werden nach den Zufallsprinzip gemischt.





Gres fine porcellanato smaltato

Glazed fine porcelain stoneware . Grès cérame fin émaillé . Glasiertes Feinsteinzeug



Terre Emiliane Mix Esagona 15,8x18,3

COTTO DEL CAMPIANO

FORMATO NOMINALE Nominal Size Format Nominal Nennformat	ARTICOLO Item Article Artikel	FASCE DI PREZZO Price Ranges Groupes Des Prix Preisgruppen	BOX			PALLET		
			PEZZI Pieces Pièces Stücke	MQ Sqm Mc Qm	KG	SCATOLE Boxes Boîtes Kartons	MQ Sqm Mc Qm	KG
 INSERTO BOBOLI * 20x20 cm 8"x8"	1081494 Inseto Boboli S/6	B16	6					
 INSERTO BOBOLI ESAGONA * 15,8x18,3 cm 6 1/4"x7 3/16"	1081495 Esagona Inseto Boboli S/6	B18	6					
 BATTISCOPIA 6,5x40 cm 2 3/16"x16"	1081497 Cotto Dorato 1081498 Giallo Umbria 1081499 Rosso Siena 1081500 Terra di Pienza	C3	20	ml 8,00	11,00			
 ELEMENTO AD "L" MONOLITICO R11 10x40x4 4"x16"x1 9/16"	1081501 Cotto Dorato 1081502 Giallo Umbria 1081503 Rosso Siena 1081504 Terra di Pienza	B24	8		9,20			

* Decorì da rivestimento ad uso residenziale interno.
Wall decorations for interior residential.
Décor mural pour usage résidentiel intérieur.
Wanddekore nur für Innenbereich geeignet.

Gres fine porcellanato smaltato

Glazed fine porcelain stoneware . Grès cérame fin émaillé . Glasiertes Feinsteinzeug



Terra di Pienza 20x20
Inseto Boboli S/6 20x20



DI PIETRA

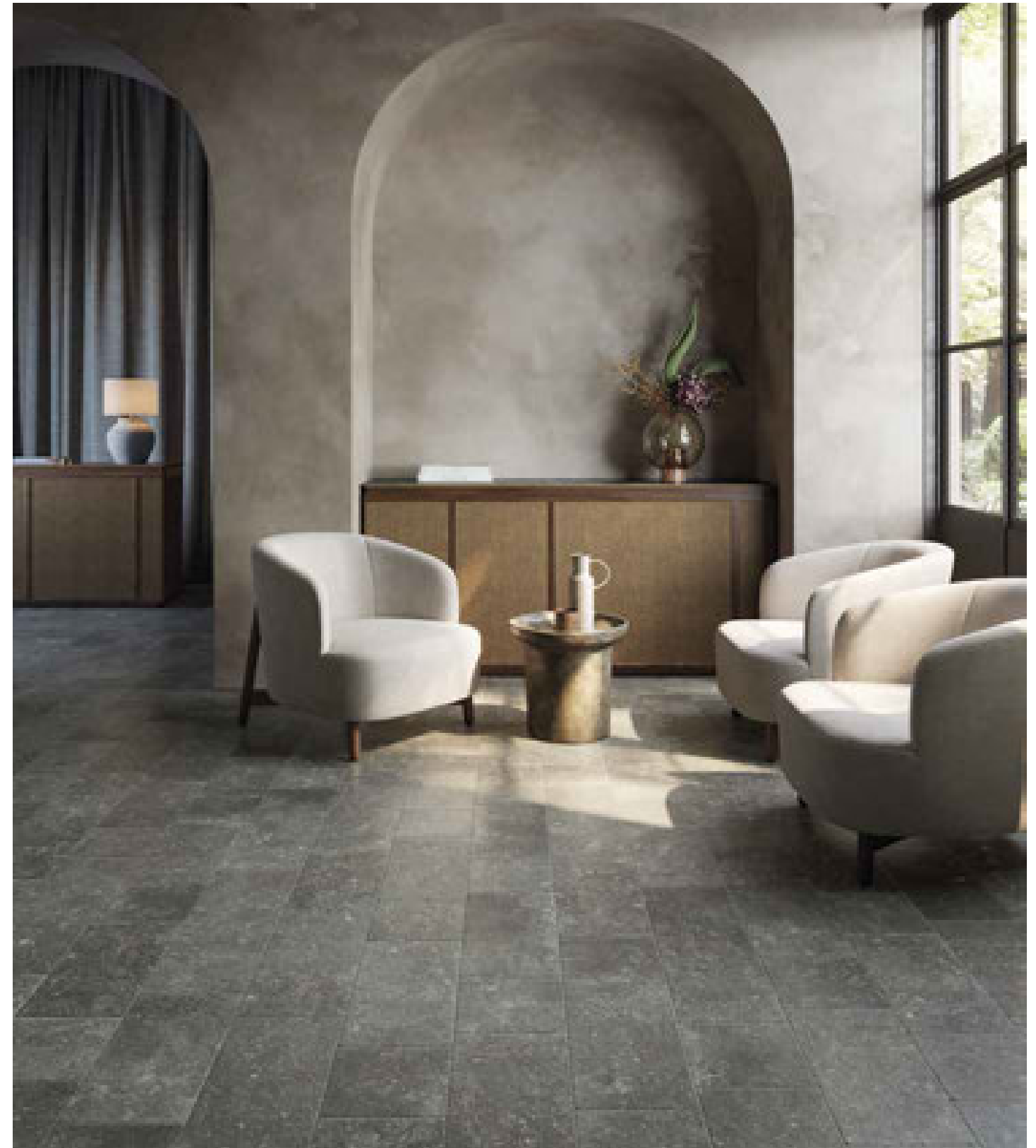



DI PIETRA

Colours

RUNI AVORIO



RUNI TORTORA

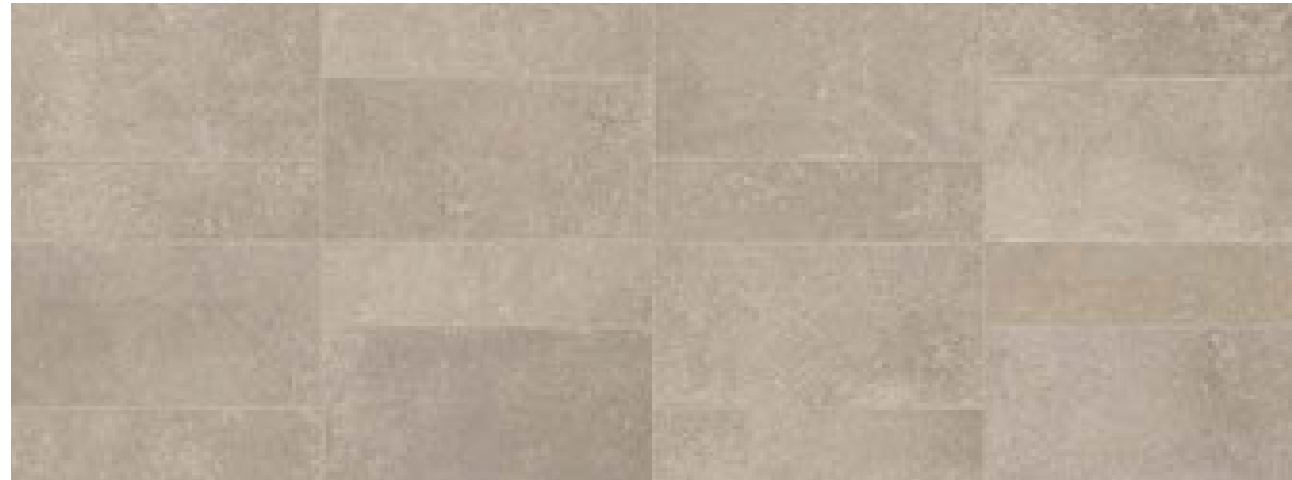

BALI RED



Gres fine porcellanato smaltato

Glazed fine porcelain stoneware . Grès cérame fin émaillé . Glasiertes Feinsteinzeug











ARDENNE GRIGIO

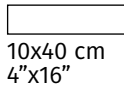

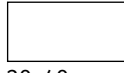
ARDENNE NERO

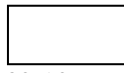

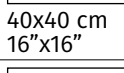

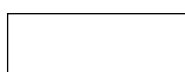



DI PIETRA

FORMATO NOMINALE Nominal Size Format Nominal Nennformat	ARTICOLO Item Article Artikel	FASCE DI PREZZO Price ranges Groupes des prix Preisgruppen	BOX			PALLET		
			PEZZI Pieces Pièces Stücke	MQ Sqm Mc Qm	KG	SCATOLE Boxes Boîtes Kartons	MQ Sqm Mc Qm	KG
 10x40 cm 4"x16"	1076932 Ardenne Grigio 1076933 Ardenne Nero 1076934 Bali Red 1076936 Runi Avorio 1076937 Runi Tortora	A13	18	0,72	14,00	72	51,84	1.024
 20x20 cm 8"x8"	1077080 Ardenne Grigio 1077081 Ardenne Nero 1077082 Bali Red 1077084 Runi Avorio 1077085 Runi Tortora	A10	26	1,04	21,00	54	56,16	1.150
 20x20 cm 8"x8" R11	1078547 Ardenne Grigio 1078548 Ardenne Nero 1078549 Bali Red 1078550 Runi Avorio 1078551 Runi Tortora	A11	26	1,04	21,00	54	56,16	1.150
 20x40 cm 8"x16"	1076235 Ardenne Grigio 1076236 Ardenne Nero 1076239 Bali Red 1076241 Runi Avorio 1076243 Runi Tortora	A10	13	1,04	21,10	54	56,16	1.154
 20x40 cm 8"x16" R11	1078552 Ardenne Grigio 1078553 Ardenne Nero 1078554 Bali Red 1078555 Runi Avorio 1078556 Runi Tortora	A11	13	1,04	21,10	54	56,16	1.154
 20x40 cm 8"x16" R11 15 mm	1076704 Ardenne Grigio 15 mm 1076705 Ardenne Nero 15 mm 1076706 Bali Red 15 mm 1076708 Runi Avorio 15 mm 1076709 Runi Tortora 15 mm	A22A	8	0,64	19,50	54	34,56	1.069
 40x40 cm 16"x16"	1076771 Ardenne Grigio 1076772 Ardenne Nero 1076773 Bali Red 1076775 Runi Avorio 1076776 Runi Tortora	A10	8	1,28	26,50	48	61,44	1.288
 40x40 cm 16"x16" R11	1078557 Ardenne Grigio 1078558 Ardenne Nero 1078559 Bali Red 1078560 Runi Avorio 1078561 Runi Tortora	A11	8	1,28	26,50	48	61,44	1.288
 40x60,8 cm 16"x24"	1075975 Ardenne Grigio 1075976 Ardenne Nero 1075980 Bali Red 1075987 Runi Avorio 1075989 Runi Tortora	A11	4	0,97	20,00	60	58,20	1.216
 40x60,8 cm 16"x24" R11	1078562 Ardenne Grigio 1078563 Ardenne Nero 1078564 Bali Red 1078565 Runi Avorio 1078566 Runi Tortora	A13	4	0,97	20,00	60	58,20	1.216

Gres fine porcellanato smaltato

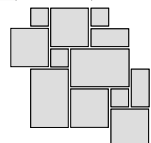
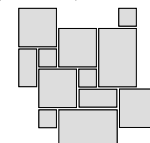

Glazed fine porcelain stoneware . Grès cérame fin émaillé . Glasiertes Feinsteinzeug

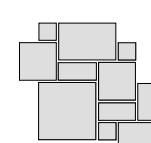
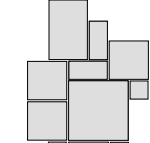

FORMATO NOMINALE Nominal Size Format Nominal Nennformat	ARTICOLO Item Article Artikel	FASCE DI PREZZO Price ranges Groupes des prix Preisgruppen	BOX			PALLET		
			PEZZI Pieces Pièces Stücke	MQ Sqm Mc Qm	KG	SCATOLE Boxes Boîtes Kartons	MQ Sqm Mc Qm	KG
 60,8x60,8 cm 24"x24"	1078567 Ardenne Grigio 1078568 Ardenne Nero	A8	3	1,11	25,00	40	44,40	1.016
 60,8x60,8 cm 24"x24" R11	1078569 Ardenne Grigio 1078570 Ardenne Nero	A10	3	1,11	25,00	40	44,40	1.016
 MODULARE 39	1077498 Ardenne Grigio 1077144 Ardenne Nero 1077265 Bali Red 1077565 Runi Avorio 1077268 Runi Tortora	A20A	6	0,723	16,00	40	28,92	656
 MODULARE 39 R11	1078571 Ardenne Grigio 1078572 Ardenne Nero 1078573 Bali Red 1078574 Runi Avorio 1078575 Runi Tortora	A22	6	0,723	16,00	40	28,92	656
Contenuto di una scatola One box contents Contenu d'une boîte Inhalt einer Schachtel	20x40 - 8"x16": 1 pc 40x40 - 16"x16": 2 pc 20x20 - 8"x8": 2 pc 40x60,8 - 16"x24": 1 pc							
 MODULARE 41	1078576 Ardenne Grigio 1078577 Ardenne Nero	A20A	11	1,452	32,30	26	37,75	856
 MODULARE 41 R11	1078581 Ardenne Grigio 1078582 Ardenne Nero	A22	11	1,452	32,30	26	37,75	856
Contenuto di una scatola One box contents Contenu d'une boîte Inhalt einer Schachtel	20x20 - 8"x8": 3 pc 20x40 - 8"x16": 3 pc 40x40 - 16"x16": 3 pc 40x60,8 - 16"x24": 1 pc 60,8x60,8 - 24"x24": 1 pc							

LA POSA MODULARE È CONSIGLIATA CON UNA FUGA DI 4-5 MM. - WE RECOMMEND MODULAR LAYING WITH A 4-5 MM ³/₁₆ JOINT.
LA POSE MODULAIRE EST CALCULÉE AVEC UN JOINT DE 4-5 MM. - DIE MODULVERLEGUNG WIRD MIT EINER MINDESTFUGE VON 4-5 MM EMPFOHLEN.

DI PIETRA

FORMATO NOMINALE Nominal Size Format Nominal Nennformat	ARTICOLO Item Article Artikel	FASCE DI PREZZO Price ranges Groupes des prix Preisgruppen	BOX			PALLET		
			PEZZI Pieces Pièces Stücke	MQ Sqm Mc Qm	KG	SCATOLE Boxes Boîtes Kartons	MQ Sqm Mc Qm	KG
 MOSAICO PAVÈ 30x30 cm 12"x12"	1080127 Mosaico Pavè Ardenne Grigio 1080128 Mosaico Pavè Ardenne Nero 1080129 Mosaico Pavè Bali Red 1080130 Mosaico Pavè Runi Avorio 1080131 Mosaico Pavè Runi Tortora	B14	5	0,45	9,50			
 BATTISCOPIA 6,5x40 cm 2 ⁹ / ₁₆ "x16"	1080132 Ardenne Grigio 1080133 Ardenne Nero 1080134 Bali Red 1080135 Runi Avorio 1080136 Runi Tortora	C3	20	ml 8,00	10,50			
 ELEMENTO AD "L" MONOLITICO R11 10x40x4 4"x16"x1 ⁹ / ₁₆ "	1080142 Ardenne Grigio 1080143 Ardenne Nero 1080144 Bali Red 1080145 Runi Avorio 1080146 Runi Tortora	B24	8		9,20			

Gres fine porcellanato smaltato

Glazed fine porcelain stoneware . Grès cérame fin émaillé . Glasiertes Feinsteinzeug



Runi Tortora 20x40 R11 15 mm



FUORITONO



Fuoribianco 10x30
Fuorimuschio 10x30



FUORITONO

Colours

FUORIBIANCO



V3

Gres fine porcellanato smaltato

Glazed fine porcelain stoneware . Grès cérame fin émaillé . Glasiertes Feinsteinzeug



BIANCO OPACO



V3

FUORIGRIGIO



V4

GRIGIO OPACO



V4

FUORIPETROLIO



V4

PETROLIO OPACO



V4

FUORITONO

Colours

FUORIBEIGE



V3

Gres fine porcellanato smaltato

Glazed fine porcelain stoneware . Grès cérame fin émaillé . Glasiertes Feinsteinzeug



BEIGE OPACO



V3

FUORIMUSCHIO



V4

MUSCHIO OPACO



V4

FUORINERO







V4

NERO OPACO

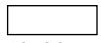

V4

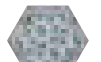
FUORITONO

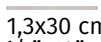
FORMATO NOMINALE Nominal Size Format Nominal Nennformat	ARTICOLO Item Article Artikel	FASCE DI PREZZO Price ranges Groupes des prix Preisgruppen	BOX			PALLET		
			PEZZI Pieces Pièces Stücke	MQ Sqm Mc Qm	KG	SCATOLE Boxes Boîtes Kartons	MQ Sqm Mc Qm	KG
 10x30 cm 4"x12"	1072366 Fuoribeige 1072367 Fuoribianco 1072368 Fuorigrigio 1072371 Fuorimuschio 1072369 Fuorinero 1072370 Fuoripetrolio	A20A	17	0,51	10,50	96	48,96	1.024
	1072372 Beige Opaco 1072373 Bianco Opaco 1072374 Grigio Opaco 1072377 Muschio Opaco 1072375 Nero Opaco 1072376 Petrolio Opaco	A13						
 ESAGONA 24x27,7 cm 9 7/16"x10 7/8"	1072701 Esagona Fuoribeige 1072702 Esagona Fuoribianco 1072703 Esagona Fuorigrigio 1072704 Esagona Fuorimuschio 1072705 Esagona Fuorinero 1072706 Esagona Fuoripetrolio	A23	20	0,97	20,50	56	54,32	1.164
	1072707 Esagona Beige Opaco 1072708 Esagona Bianco Opaco 1072709 Esagona Grigio Opaco 1072710 Esagona Muschio Opaco 1072711 Esagona Nero Opaco 1072712 Esagona Petrolio Opaco	A19						
 ROMBO 13,7x24 cm 5 3/8"x9 7/16"	1072715 Rombo Fuoribianco 1072718 Rombo Fuorimuschio 1072720 Rombo Fuorinero 1072719 Rombo Fuoripetrolio	A28	66	1,07	23,20	56	59,92	1.320
	1072722 Rombo Bianco Opaco 1072724 Rombo Muschio Opaco 1072723 Rombo Nero Opaco 1072726 Rombo Petrolio Opaco	A23						
 FUORIMAIOLICA ESAGONA * 24x27,7 cm 9 7/16"x10 7/8"	1073733 Esagona Fuorimaiolica Mix S/6	B18	6					
 FUORIDAMASCO ESAGONA * 24x27,7 cm 9 7/16"x10 7/8"	1073734 Esagona Fuoridamasco Mix S/6 1073735 Esagona Fuoridamasco Blu S/6 1073737 Esagona Fuoridamasco Rosso S/6 1073736 Esagona Fuoridamasco Nero S/6	B18	6					
 1,3x30 cm 1/2"x12"	1073971 Profilo Fuoribeige 1073972 Profilo Fuoribianco 1073973 Profilo Fuorigrigio 1073974 Profilo Fuorimuschio 1073975 Profilo Fuorinero 1073976 Profilo Fuoripetrolio	B11	24	3,60				
	1073965 Profilo Beige Opaco 1073966 Profilo Bianco Opaco 1073967 Profilo Grigio Opaco 1073968 Profilo Muschio Opaco 1073969 Profilo Nero Opaco 1073970 Profilo Petrolio Opaco							

* Decori da rivestimento ad uso residenziale interno.
 Wall decorations for interior residential.
 Décor mural pour usage résidentiel intérieur.
 Wanddekore nur für Innenbereich geeignet.

Gres fine porcellanato smaltato

Glazed fine porcelain stoneware . Grès cérame fin émaillé . Glasiertes Feinsteinzeug



Esagona Fuoribianco 24x27,7
 Esagona Fuoridamasco Mix 24x27,7



HAVANA



Sugar Cane 10x20
Finca Vigia Mix 20x20



HAVANA

Colours

COHIBA



HAVANA SKY

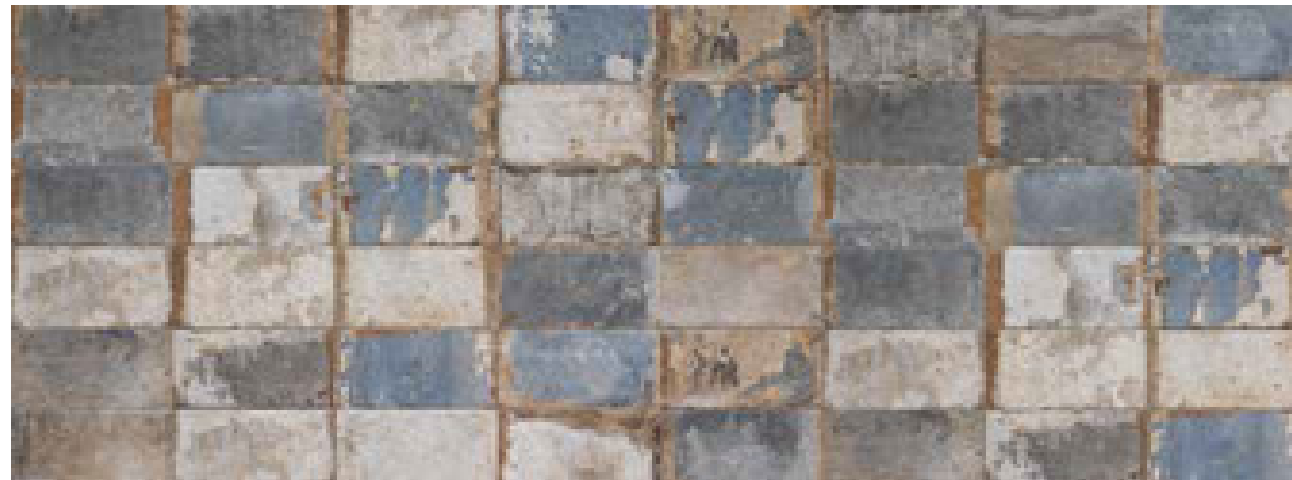

MALECON



Gres fine porcellanato smaltato

Glazed fine porcelain stoneware . Grès cérame fin émaillé . Glasiertes Feinsteinzeug



MOJITO



SUGAR CANE



TROPICANA



HAVANA

Colours

OLD HAVANA MIX



CUBA LIBRE MIX *



FINCA VIGIA MIX **



Gres fine porcellanato smaltato

Glazed fine porcelain stoneware . Grès cérame fin émaillé . Glasiertes Feinsteinzeug



PILAR BLU



PILAR VERDE



* 30 soggetti miscelati casualmente nelle scatole.











30 designs available with each box containing a random mix.
30 motifs mélangés au hasard dans les boîtes.

Die 30 Muster in den Schachteln werden nach dem Zufallsprinzip gemischt.

** 12 soggetti miscelati casualmente nelle scatole.

12 designs available with each box containing a random mix.
12 motifs mélangés au hasard dans les boîtes.





Die 12 Muster in den Schachteln werden nach dem Zufallsprinzip gemischt.

FORMATO NOMINALE Nominal Size Format Nominal Nennformat	ARTICOLO Item Article Artikel	FASCE DI PREZZO Price ranges Groupes des prix Preisgruppen	BOX			PALLET		
			PEZZI Pieces Pièces Stücke	MQ Sqm Mc Qm	KG	SCATOLE Boxes Boîtes Kartons	MQ Sqm Mc Qm	KG
 10x20 cm 4"x8"	1052958 Cohiba 1052960 Havana Sky 1052961 Malecon 1052962 Mojito 1052964 Sugar Cane 1052965 Tropicana	A11	36	0,72	14,00	72	51,84	1.024
 10x20 cm 4"x8"	1052963 Old Havana Mix	A13	36	0,72	14,00	72	51,84	1.024
 CUBA LIBRE MIX * 10x20 cm 4"x8"	1052959 Cuba Libre Mix	A20A	36	0,72	14,00	72	51,84	1.024
 20x20 cm 8"x8"	1052969 Cohiba 1052970 Havana Sky 1052971 Malecon 1052972 Mojito 1052974 Sugar Cane 1052975 Tropicana	A10	26	1,04	21,00	54	56,16	1.150
 FINCA VIGIA MIX * 20x20 cm 8"x8"	1052973 Finca Vigia Mix	A19	26	1,04	21,00	54	56,16	1.150
 PILAR 20x20 cm 8"x8"	1053543 Pilar Blu 1053544 Pilar Verde	A19	26	1,04	21,00	54	56,16	1.150
 20x40 cm 8"x16"	1053372 Cohiba 1053373 Havana Sky 1053374 Malecon 1053375 Mojito 1053376 Sugar Cane 1053377 Tropicana	A10	13	1,04	21,10	54	56,16	1.154
 40x40 cm 16"x16"	1052966 Cohiba 1052967 Malecon 1052968 Sugar Cane	A10	8	1,28	26,50	48	61,44	1.288
 MOSAICO SPACCO 30x40 cm 12"x16" 7,5x7,5 cm 3"x3"	1055132 Mosaico Spacco Cohiba 1055133 Mosaico Spacco Havana Sky 1055134 Mosaico Spacco Malecon 1055135 Mosaico Spacco Mojito 1055136 Mosaico Spacco Sugar Cane 1055137 Mosaico Spacco Tropicana	B16	5	0,60	13,00			
 INSERTO PALOMA LAPPATO ** 20x20 cm 8"x8"	1054791 Inserto Paloma S/8 Lappato	B18	8					

Gres fine porcellanato smaltato

Glazed fine porcelain stoneware . Grès cérame fin émaillé . Glasiertes Feinsteinzeug



FORMATO NOMINALE Nominal Size Format Nominal Nennformat	ARTICOLO Item Article Artikel	FASCE DI PREZZO Price ranges Groupes des prix Preisgruppen	BOX			PALLET		
			PEZZI Pieces Pièces Stücke	MQ Sqm Mc Qm	KG	SCATOLE Boxes Boîtes Kartons	MQ Sqm Mc Qm	KG
 INSERTO PALOMA V ** 40x40 cm 16"x16"	1054797 Inserto Paloma V	B32	4	0,64	12,80			
 BATTISCOPA 6,5x40 cm 2 ⁹ / ₁₆ "x16"	1053488 Cohiba 1053489 Malecon 1053490 Sugar Cane	C3	20	ml 8,00	10,00			
 ELEMENTO AD "L" MONOLITICO 10x40x4 4"x16"x ¹⁹ / ₁₆ "	1053491 Cohiba 1053492 Malecon 1053493 Sugar Cane	B24	8		9,20			
 ELEMENTO AD "L" 10x4x15 cm 4"x1 ⁹ / ₁₆ "x6"	1061649 Havana Sky 1061650 Malecon 1061651 Mojito 1061652 Sugar Cane 1061653 Tropicana	B10	10		3,20			

* **Soggetti miscelati casualmente nelle scatole.**

Designs available with each box containing a random mix.
Motifs mélangés au hasard dans les boîtes.
Die Muster in den Schachteln werden nach den Zufallsprinzip gemischt.

** **Decorì da rivestimento ad uso residenziale interno.**

Wall decorations for interior residential.
Décor mural pour usage résidentiel intérieur.
Wanddekore nur für Innenbereich geeignet.



HERITAGE





HERITAGE

Colours

GREY



IVORY



WALNUT









Gres fine porcellanato smaltato

Glazed fine porcelain stoneware . Grès cérame fin émaillé . Glasiertes Feinsteinzeug

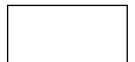

Walnut modulare 39
Walnut 20x40

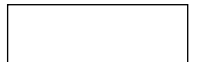





HERITAGE

FORMATO NOMINALE Nominal Size Format Nominal Nennformat	ARTICOLO Item Article Artikel	FASCE DI PREZZO Price ranges Groupes des prix Preisgruppen	BOX			PALLET		
			PEZZI Pieces Pièces Stücke	MQ Sqm Mc Qm	KG	SCATOLE Boxes Boîtes Kartons	MQ Sqm Mc Qm	KG
 20x20 cm 8"x8"	1080524 Heritage Grey 1080525 Heritage Ivory 1080526 Heritage Walnut	A10	26	1,04	21,00	54	56,16	1.150
 20x20 cm 8"x8" R11	1080536 Heritage Grey 1080537 Heritage Ivory 1080538 Heritage Walnut	A11	26	1,04	21,00	54	56,16	1.150
 20x40 cm 8"x16"	1080527 Heritage Grey 1080528 Heritage Ivory 1080529 Heritage Walnut	A10	13	1,04	21,10	54	56,16	1.154
 20x40 cm 8"x16" R11	1080539 Heritage Grey 1080540 Heritage Ivory 1080541 Heritage Walnut	A11	13	1,04	21,10	54	56,16	1.154
 40x40 cm 16"x16"	1080530 Heritage Grey 1080531 Heritage Ivory 1080532 Heritage Walnut	A10	8	1,28	26,50	48	61,44	1.288
 40x40 cm 16"x16" R11	1080542 Heritage Grey 1080543 Heritage Ivory 1080544 Heritage Walnut	A11	8	1,28	26,50	48	61,44	1.288
 40x60,8 cm 16"x24"	1080533 Heritage Grey 1080534 Heritage Ivory 1080535 Heritage Walnut	A11	4	0,97	20,00	60	58,20	1.216
 40x60,8 cm 16"x24" R11	1080545 Heritage Grey 1080546 Heritage Ivory 1080547 Heritage Walnut	A13	4	0,97	20,00	60	58,20	1.216

Gres fine porcellanato smaltato

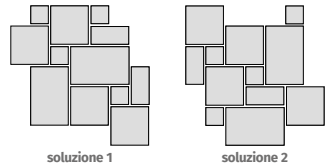
Glazed fine porcelain stoneware . Grès cérame fin émaillé . Glasiertes Feinsteinzeug



FORMATO NOMINALE Nominal Size Format Nominal Nennformat	ARTICOLO Item Article Artikel	FASCE DI PREZZO Price ranges Groupes des prix Preisgruppen	BOX			PALLET		
			PEZZI Pieces Pièces Stücke	MQ Sqm Mc Qm	KG	SCATOLE Boxes Boîtes Kartons	MQ Sqm Mc Qm	KG
 MODULARE 39	1080548 Heritage Grey 1080549 Heritage Ivory 1080550 Heritage Walnut	A20A	6	0,723	16,00	40	28,92	656
 MODULARE 39 R11	1080551 Heritage Grey 1080552 Heritage Ivory 1080553 Heritage Walnut	A22	6	0,723	16,00	40	28,92	656
Contenuto di una scatola One box contents Contenu d'une boîte Inhalt einer Schachtel	20x40 - 8"x16": 1 pc 40x40 - 16"x16": 2 pc 20x20 - 8"x8": 2 pc 40x60,8 - 16"x24": 1 pc							
 MOSAICO ESAGONA 36x31 cm 14 ¹³ / ₁₆ " x 12 ³ / ₁₆ "	1080587 Heritage Mosaico Esagona Grey 1080588 Heritage Mosaico Esagona Ivory 1080589 Heritage Mosaico Esagona Walnut	B19	6					
 MOSAICO TESSERA 30x30 cm 12"x12" 5x5 cm 2"x2"	1080554 Heritage Mosaico Grey 1080555 Heritage Mosaico Ivory 1080556 Heritage Mosaico Walnut	B13	5	0,45	10,00			
 BATTISCOPA 6,5x40 cm 2 ³ / ₁₆ " x 16"	1080558 Heritage Grey 1080559 Heritage Ivory 1080560 Heritage Walnut	C3	20	ml 8,00	11,00			
 ELEMENTO AD "L" MONOLITICO R11 10x40x4 4"x16"x1 ⁹ / ₁₆ "	1080561 Heritage Grey 1080562 Heritage Ivory 1080564 Heritage Walnut	B24	8		9,20			

LA POSA MODULARE È CONSIGLIATA CON UNA FUGA DI 4-5 MM. - WE RECOMMEND MODULAR LAYING WITH A 4-5 MM ³/₁₆ JOINT.
LA POSE MODULAIRE EST CALCULÉE AVEC UN JOINT DE 4-5 MM. - DIE MODULVERLEGUNG WIRD MIT EINER MINDESTFUGE VON 4-5 MM EMPFOHLEN.



IN FALDA

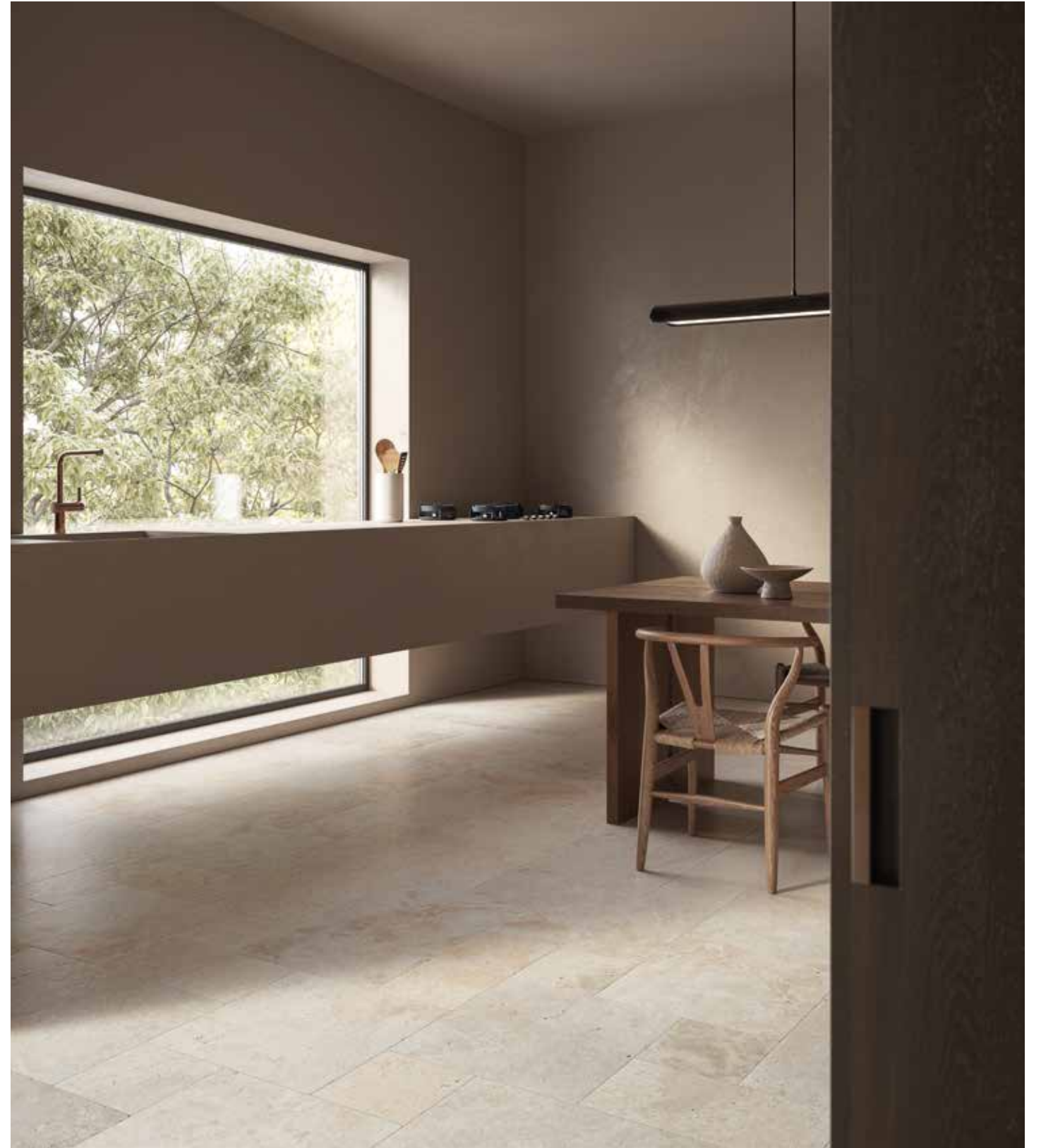



IN FALDA

Colours

PERLATO DI SICILIA



TRAVERTINO NAVONA



PIETRA DI RAPOLANO



Gres fine porcellanato smaltato







Glazed fine porcelain stoneware . Grès cérame fin émaillé .
Glasiertes Feinsteinzeug



MARMO PRIMAVERA

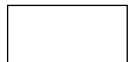

IN FALDA

FORMATO NOMINALE Nominal Size Format Nominal Nennformat	ARTICOLO Item Article Artikel	FASCE DI PREZZO Price ranges Groupes des prix Preisgruppen	BOX			PALLET		
			PEZZI Pieces Pièces Stücke	MQ Sqm Mc Qm	KG	SCATOLE Boxes Boîtes Kartons	MQ Sqm Mc Qm	KG
 20x20 cm 8"x8"	1072810 Marmo Primavera 1072811 Perlato di Sicilia 1072812 Pietra di Rapolano 1072813 Travertino Navona	A10	26	1,04	21,00	54	56,16	1.150
 20x20 cm 8"x8" R11	1073279 Marmo Primavera 1073280 Perlato di Sicilia 1073281 Pietra di Rapolano 1073282 Travertino Navona	A11	26	1,04	21,00	54	56,16	1.150
 20x40 cm 8"x16"	1072802 Marmo Primavera 1072803 Perlato di Sicilia 1072804 Pietra di Rapolano 1072805 Travertino Navona	A10	13	1,04	21,10	54	56,16	1.154
 20x40 cm 8"x16" R11	1073287 Marmo Primavera 1073288 Perlato di Sicilia 1073289 Pietra di Rapolano 1073290 Travertino Navona	A11	13	1,04	21,10	54	56,16	1.154
 40x40 cm 16"x16"	1072806 Marmo Primavera 1072807 Perlato di Sicilia 1072808 Pietra di Rapolano 1072809 Travertino Navona	A10	8	1,28	26,50	48	61,44	1.288
 40x40 cm 16"x16" R11	1073283 Marmo Primavera 1073284 Perlato di Sicilia 1073285 Pietra di Rapolano 1073286 Travertino Navona	A11	8	1,28	26,50	48	61,44	1.288
 40x60,8 cm 16"x24"	1072818 Marmo Primavera 1072819 Perlato di Sicilia 1072820 Pietra di Rapolano 1072821 Travertino Navona	A11	4	0,97	20,00	60	58,20	1.216
 40x60,8 cm 16"x24" R11	1073291 Marmo Primavera 1073292 Perlato di Sicilia 1073293 Pietra di Rapolano 1073294 Travertino Navona	A13	4	0,97	20,00	60	58,20	1.216

Gres fine porcellanato smaltato







Glazed fine porcelain stoneware . Grès cérame fin émaillé .
Glasiertes Feinsteinzeug



60,4x60,4 . 24"x24" → U4 P4+ E3 C2



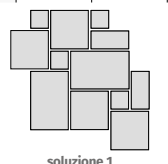
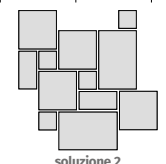

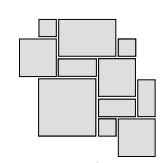
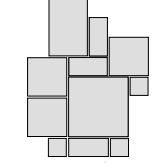

R11

FORMATO NOMINALE Nominal Size Format Nominal Nennformat	ARTICOLO Item Article Artikel	FASCE DI PREZZO Price ranges Groupes des prix Preisgruppen	BOX			PALLET		
			PEZZI Pieces Pièces Stücke	MQ Sqm Mc Qm	KG	SCATOLE Boxes Boîtes Kartons	MQ Sqm Mc Qm	KG
 60,8x60,8 cm 24"x24"	1073638 Marmo Primavera 1073639 Perlato di Sicilia 1073640 Pietra di Rapolano 1073641 Travertino Navona	A8	3	1,11	25,00	40	44,40	1.016
 60,8x60,8 cm 24"x24" R11	1073642 Marmo Primavera 1073643 Perlato di Sicilia 1073644 Pietra di Rapolano 1073645 Travertino Navona	A10	3	1,11	25,00	40	44,40	1.016
 MODULARE 39	1073583 Marmo Primavera 1073584 Perlato di Sicilia 1073585 Pietra di Rapolano 1073586 Travertino Navona	A20A	6	0,723	16,00	40	28,92	656
 MODULARE 39 R11	1073728 Marmo Primavera 1073729 Perlato di Sicilia 1073730 Pietra di Rapolano 1073731 Travertino Navona	A22	6	0,723	16,00	40	28,92	656
Contenuto di una scatola One box contents Contenu d'une boîte Inhalt einer Schachtel	20x40 - 8"x16": 1 pc 40x40 - 16"x16": 2 pc 20x20 - 8"x8": 2 pc 40x60,8 - 16"x24": 1 pc							
 MODULARE 41	1074538 Marmo Primavera 1074539 Perlato di Sicilia 1074540 Pietra di Rapolano 1074541 Travertino Navona	A20A	11	1,452	32,30	26	37,75	856
 MODULARE 41 R11	1074542 Marmo Primavera 1074543 Perlato di Sicilia 1074544 Pietra di Rapolano 1074545 Travertino Navona	A22	11	1,452	32,30	26	37,75	856
Contenuto di una scatola One box contents Contenu d'une boîte Inhalt einer Schachtel	20x20 - 8"x8": 3 pc 20x40 - 8"x16": 3 pc 40x40 - 16"x16": 3 pc 40x60,8 - 16"x24": 1 pc 60,8x60,8 - 24"x24": 1 pc							

LA POSA MODULARE È CONSIGLIATA CON UNA FUGA DI 4-5 MM. - WE RECOMMEND MODULAR LAYING WITH A 4-5 MM ³/₁₆ JOINT.
LA POSE MODULAIRE EST CALCULÉE AVEC UN JOINT DE 4-5 MM. - DIE MODULVERLEGUNG WIRD MIT EINER MINDESTFUGE VON 4-5 MM EMPFOHLEN.

IN FALDA

FORMATO NOMINALE Nominal Size Format Nominal Nennformat	ARTICOLO Item Article Artikel	FASCE DI PREZZO Price ranges Groupes des prix Preisgruppen	BOX			PALLET		
			PEZZI Pieces Pièces Stücke	MQ Sqm Mc Qm	KG	SCATOLE Boxes Boîtes Kartons	MQ Sqm Mc Qm	KG
 MOSAICO TESSERA 30x30 cm 12"x12" 5x5 cm 2"x2"	1073845 Mosaico Marmo Primavera 1073846 Mosaico Perlato di Sicilia 1073847 Mosaico Pietra di Rapolano 1073848 Mosaico Travertino Navona	B13	5	0,45	10,00			
 INSERTO MODERNO * 20x20 cm 8"x8"	1080126 Inserto Moderno S/6	B12	6	0,24	4,73			
 BATTISCOPA 6,5x40 cm 2 ⁹ / ₁₆ "x16"	1073849 Marmo Primavera 1073850 Perlato di Sicilia 1073851 Pietra di Rapolano 1073852 Travertino Navona	C3	20	ml 8,00	11,00			
 ELEMENTO AD "L" MONOLITICO R11 10x40x4 4"x16"x1 ⁹ / ₁₆ "	1073857 Marmo Primavera 1073858 Perlato di Sicilia 1073859 Pietra di Rapolano 1073860 Travertino Navona	B24	8		9,20			

* **Decorì da rivestimento ad uso residenziale interno.**
 Wall decorations for interior residential.
 Décor mural pour usage résidentiel intérieur.
 Wanddekore nur für Innenbereich geeignet.

Gres fine porcellanato smaltato

Glazed fine porcelain stoneware . Grès cérame fin émaillé .
 Glasiertes Feinsteinzeug



Marmo Primavera 60,8x60,8 / 20x20
 Inserto Moderno S/6 20x20

IN FALDA 2 cm outdoor

Colours

PERLATO DI SICILIA



TRAVERTINO NAVONA







MARMO PRIMAVERA

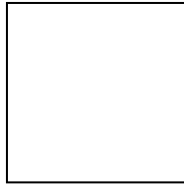

Gres fine porcellanato smaltato

Glazed fine porcelain stoneware . Grès cérame fin émaillé . Glasiertes Feinsteinzeug

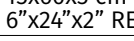

FORMATO NOMINALE Nominal Size Format Nominal Nennformat	ARTICOLO Item Article Artikel	FASCE DI PREZZO Price ranges Groupes des prix Preisgruppen	BOX			PALLET		
			PEZZI Pieces Pièces Stücke	MQ Sqm Mc Qm	KG	SCATOLE Boxes Boîtes Kartons	MQ Sqm Mc Qm	KG
 60x60 cm 24"x24" RETT R11	1075221 Marmo Primavera 1075222 Perlato di Sicilia 1075223 Travertino Navona	A36	2	0,72	32,30	32	23,04	1.082
 STEP MOLATO 30x60 cm 12"x24" RETT R11	1075321 Marmo Primavera 1075322 Perlato di Sicilia 1075323 Travertino Navona	B36	3		24,30			
 STEP TORATO 30x60 cm 12"x24" RETT R11	1075324 Marmo Primavera 1075325 Perlato di Sicilia 1075326 Travertino Navona	B37	3		24,30			
 ELEMENTO AD "L" ASSEMBLATO 15x60x5 cm 6"x24"x2" RETT R11	1075327 Marmo Primavera 1075328 Perlato di Sicilia 1075329 Travertino Navona	B45	4		22,00			
 GRADONE COSTA RETTA 35x60x5 cm 13 3/4"x24"x2" RETT R11	1075330 Marmo Primavera 1075335 Perlato di Sicilia 1075336 Travertino Navona	B52	2		18,90			



Perlato di Sicilia 60x60 R11 2 CM rett
Perlato di Sicilia pezzi speciali R11 2 CM rett



ITALICA

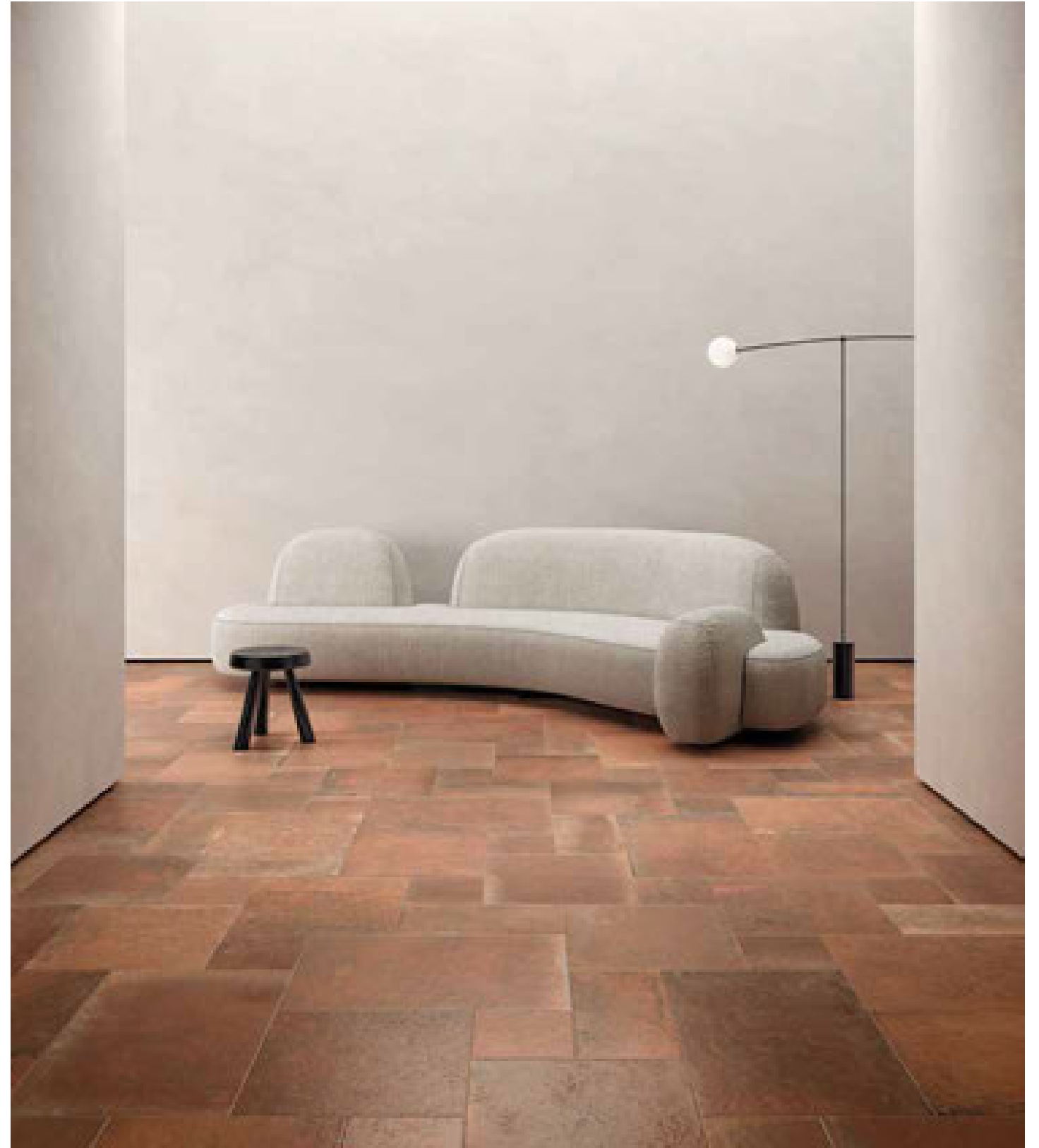



ITALICA

Colours

TERRA MISTA



TERRA DOLCE



TERRA BRUCIATA



Gres fine porcellanato smaltato

Glazed fine porcelain stoneware . Grès cérame fin émaillé . Glasiertes Feinsteinzeug



TERRA SALINA



TERRA ARSA



TERRA VERDE



ITALICA

Colours

TERRA BLU



Gres fine porcellanato smaltato

Glazed fine porcelain stoneware . Grès cérame fin émaillé . Glasiertes Feinsteinzeug



Terra Blu Esagona 24x27,7

ITALICA

Colours

TERRA CLASSICA MIX *



TERRA NUOVA MIX **



TERRA MODERNA ESAGONA



Gres fine porcellanato smaltato

Glazed fine porcelain stoneware . Grès cérame fin émaillé . Glasiertes Feinsteinzeug











Terra Nuova Mix 20x20

*** 19 soggetti miscelati casualmente nelle scatole.**

19 designs available with each box containing a random mix.
19 motifs mélangés au hasard dans les boîtes.
Die 19 Muster in den Schachteln werden nach den Zufallsprinzip gemischt.

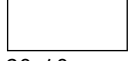
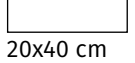
**** 20 soggetti miscelati casualmente nelle scatole.**





20 designs available with each box containing a random mix.
20 motifs mélangés au hasard dans les boîtes.
Die 20 Muster in den Schachteln werden nach den Zufallsprinzip gemischt.

FORMATO NOMINALE Nominal Size Format Nominal Nennformat	ARTICOLO Item Article Artikel	FASCE DI PREZZO Price ranges Groupes des prix Preisgruppen	BOX			PALLET		
			PEZZI Pieces Pièces Stücke	MQ Sqm Mc Qm	KG	SCATOLE Boxes Boîtes Kartons	MQ Sqm Mc Qm	KG
 20x20 cm 8"x8"	1086479 Terra Arsa 1086855 Terra Blu 1086480 Terra Bruciata 1086481 Terra Dolce 1086482 Terra Mista 1086483 Terra Salina 1086856 Terra Verde	A10	26	1,04	21,00	54	56,16	1.150
 TERRA CLASSICA MIX * 20x20 cm 8"x8"	1086809 Terra Classica Mix Blu 1086854 Terra Classica Mix Verde	A19	26	1,04	21,00	54	56,16	1.150
 TERRA NUOVA MIX * 20x20 cm 8"x8"	1086810 Terra Nuova Mix	A19	26	1,04	21,00	54	56,16	1.150
 20x20 cm 8"x8" R11	1086484 Terra Arsa 1086485 Terra Bruciata 1086486 Terra Dolce 1086487 Terra Mista 1086488 Terra Salina	A11	26	1,04	21,00	54	56,16	1.150
 20x40 cm 8"x16"	1086496 Terra Arsa 1086497 Terra Bruciata 1086498 Terra Dolce 1086499 Terra Mista 1086500 Terra Salina	A10	13	1,04	21,10	54	56,16	1.154
 20x40 cm 8"x16" R11	1086501 Terra Arsa 1086502 Terra Bruciata 1086503 Terra Dolce 1086504 Terra Mista 1086505 Terra Salina	A11	13	1,04	21,10	54	56,16	1.154
 40x40 cm 16"x16"	1086506 Terra Arsa 1086507 Terra Bruciata 1086508 Terra Dolce 1086509 Terra Mista 1086510 Terra Salina	A10	8	1,28	26,50	48	61,44	1.288
 40x40 cm 16"x16" R11	1086511 Terra Arsa 1086512 Terra Bruciata 1086513 Terra Dolce 1086514 Terra Mista 1086515 Terra Salina	A11	8	1,28	26,50	48	61,44	1.288
 40x60,8 cm 16"x24"	1086516 Terra Arsa 1086517 Terra Bruciata 1086518 Terra Dolce 1086519 Terra Mista 1086520 Terra Salina	A11	4	0,97	20,00	60	58,20	1.216

Gres fine porcellanato smaltato

Glazed fine porcelain stoneware . Grès cérame fin émaillé . Glasiertes Feinsteinzeug



FORMATO NOMINALE Nominal Size Format Nominal Nennformat	ARTICOLO Item Article Artikel	FASCE DI PREZZO Price ranges Groupes des prix Preisgruppen	BOX			PALLET		
			PEZZI Pieces Pièces Stücke	MQ Sqm Mc Qm	KG	SCATOLE Boxes Boîtes Kartons	MQ Sqm Mc Qm	KG
 40x60,8 cm 16"x24" R11	1086521 Terra Arsa 1086522 Terra Bruciata 1086523 Terra Dolce 1086524 Terra Mista 1086525 Terra Salina	A13	4	0,97	20,00	60	58,20	1.216
 ESAGONA 24x27,7 cm 9 7/16"x10 7/8"	1086934 Esagona Terra Arsa 1086935 Esagona Terra Blu 1086936 Esagona Terra Bruciata 1086937 Esagona Terra Dolce 1086938 Esagona Terra Mista 1086939 Esagona Terra Salina 1086940 Esagona Terra Verde	A19	20	0,97	20,50	56	54,32	1.164
 TERRA MODERNA ESAGONA 24x27,7 cm 9 7/16"x10 7/8"	1087199 Esagona Terra Moderna Blu 1087200 Esagona Terra Moderna Dolce 1087201 Esagona Terra Moderna Mista 1087202 Esagona Terra Moderna Verde	A26A	20	0,97	20,50	56	54,32	1.164
 MODULARE 39	1086526 Terra Arsa 1086527 Terra Bruciata 1086528 Terra Dolce 1086529 Terra Mista 1086530 Terra Salina	A20A	6	0,723	16,00	40	28,92	656
 MODULARE 39 R11	1086531 Terra Arsa 1086532 Terra Bruciata 1086533 Terra Dolce 1086534 Terra Mista 1086535 Terra Salina	A22	6	0,723	16,00	40	28,92	656
Contenuto di una scatola One box contents Contenu d'une boîte Inhalt einer Schachtel	20x40 - 8"x16": 1 pc 40x40 - 16"x16": 2 pc 20x20 - 8"x8": 2 pc 40x60,8 - 16"x24": 1 pc							

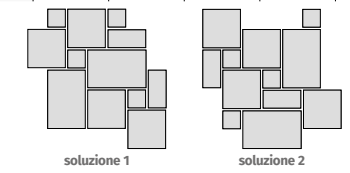



LA POSA MODULARE È CONSIGLIATA CON UNA FUGA DI 4-5 MM. - WE RECOMMEND MODULAR LAYING WITH A 4-5 MM ³/₁₆ JOINT.
LA POSE MODULAIRE EST CALCULÉE AVEC UN JOINT DE 4-5 MM. - DIE MODULVERLEGUNG WIRD MIT EINER MINDESTFUGE VON 4-5 MM EMPFOHLEN.

* **Soggetti miscelati casualmente nelle scatole.**

Designs available with each box containing a random mix.
Motifs mélangés au hasard dans les boîtes.
Die Muster in den Schachteln werden nach den Zufallsprinzip gemischt.

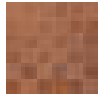
ITALICA

FORMATO NOMINALE Nominal Size Format Nominal Nennformat	ARTICOLO Item Article Artikel	FASCE DI PREZZO Price ranges Groupes des prix Preisgruppen	BOX			PALLET		
			PEZZI Pieces Pièces Stücke	MQ Sqm Mc Qm	KG	SCATOLE Boxes Boîtes Kartons	MQ Sqm Mc Qm	KG
 MOSAICO TESSERA 30x30 cm 12"x12" 5x5 cm 2"x2"	1086269 Mosaico Terra Arsa 1088302 Mosaico Terra Blu 1086270 Mosaico Terra Bruciata 1086271 Mosaico Terra Dolce 1086272 Mosaico Terra Mista 1086273 Mosaico Terra Salina 1088303 Mosaico Terra Verde	B13	5	0,45	10,00			
 MOSAICO ESAGONA 25x30 cm 10"x12" RETT	1087590 Mosaico Esagona Terra Arsa 1088304 Mosaico Esagona Terra Blu 1087591 Mosaico Esagona Terra Bruciata 1087592 Mosaico Esagona Terra Dolce 1087593 Mosaico Esagona Terra Mista 1087594 Mosaico Esagona Terra Salina 1088305 Mosaico Esagona Terra Verde	B19	5	0,38	10,00			
 BATTISCOPIA 6,5x40 cm 2 ⁹ / ₁₆ "x16"	1086536 Terra Arsa 1086537 Terra Bruciata 1086538 Terra Dolce 1086539 Terra Mista 1086540 Terra Salina	C3	20	ml 8,00	10,50			
 ELEMENTO AD "L" MONOLITICO R11 10x40x4 4"x16"x1 ⁹ / ₁₆ "	1086541 Terra Arsa 1086542 Terra Bruciata 1086543 Terra Dolce 1086544 Terra Mista 1086545 Terra Salina	B24	8		9,20			

Gres fine porcellanato smaltato

Glazed fine porcelain stoneware . Grès cérame fin émaillé . Glasiertes Feinsteinzeug



Terra Verde 20x20
Terra Classica Mix Verde 20x20



MATERIA PRIMA



Cloud White 10x20
Navy Sea 10x20
North Pole 40x40 / 10x20



MATERIA PRIMA

Colours

CLOUD WHITE



GREY VETIVER



METROPOLITAN GREY

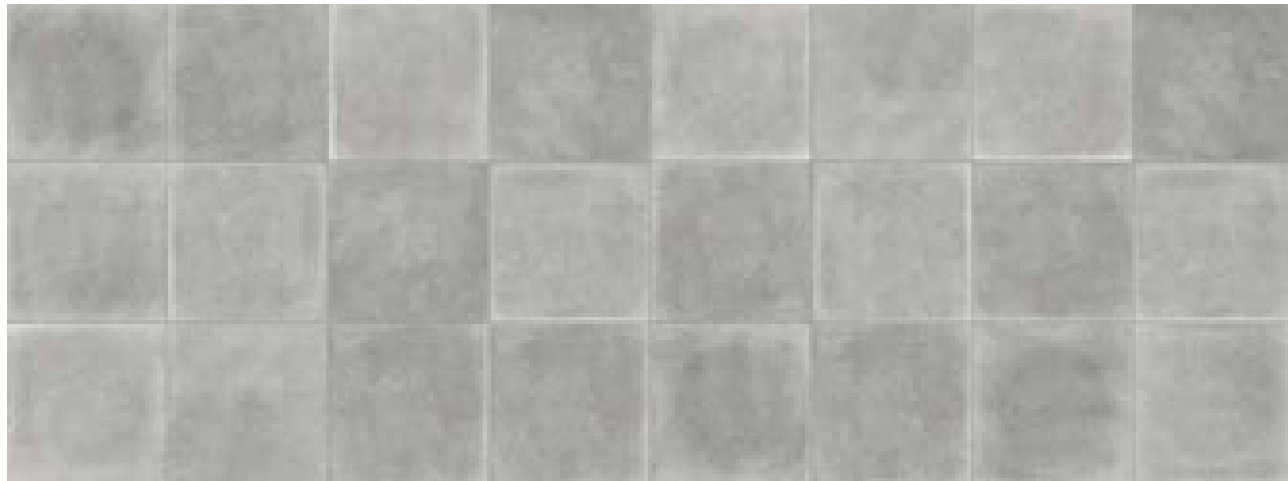

Gres fine porcellanato smaltato

Glazed fine porcelain stoneware . Grès cérame fin émaillé . Glasiertes Feinsteinzeug

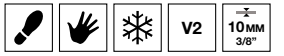

BLACK STORM



PINK VELVET



JEWEL



MATERIA PRIMA

Colours

SOFT MINT



HUNTER GREEN



NORTH POLE



Gres fine porcellanato smaltato

Glazed fine porcelain stoneware . Grès cérame fin émaillé . Glasiertes Feinsteinzeug

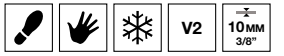







NAVY SEA



Rombo Cloud White, Metropolitan Grey 13,7x24
Esagona Cloud White, Metropolitan Grey 24x27,7





MATERIA PRIMA

FORMATO NOMINALE Nominal Size Format Nominal Nennformat	ARTICOLO Item Article Artikel	FASCE DI PREZZO Price ranges Groupes des prix Preisgruppen	BOX			PALLET		
			PEZZI Pieces Pièces Stücke	MQ Sqm Mc Qm	KG	SCATOLE Boxes Boîtes Kartons	MQ Sqm Mc Qm	KG
 10x20 cm 4"x8"	1069757 Black Storm 1069758 Cloud White 1069759 Grey Vetiver 1069760 Hunter Green 1069761 Jewel 1069762 Metropolitan Grey 1069763 Navy Sea 1069764 North Pole 1069765 Pink Velvet 1069766 Soft Mint	A17	36	0,72	14,20	72	51,84	1.024
 20x20 cm 8"x8"	1069767 Black Storm 1069768 Cloud White 1069769 Grey Vetiver 1069770 Hunter Green 1069771 Jewel 1069772 Metropolitan Grey 1069773 Navy Sea 1069774 North Pole 1069775 Pink Velvet 1069776 Soft Mint	A15	26	1,04	21,00	54	56,16	1.150
 ESAGONA 24x27,7 cm 9 ⁷ / ₁₆ "x10 ⁷ / ₈ "	1069777 Esagona Black Storm 1069778 Esagona Cloud White 1069779 Esagona Grey Vetiver 1069780 Esagona Hunter Green 1069781 Esagona Jewel 1069782 Esagona Metropolitan Grey 1069783 Esagona Navy Sea 1069784 Esagona North Pole 1069785 Esagona Pink Velvet 1069786 Esagona Soft Mint	A23	20	0,97	20,50	56	54,32	1.164
 ROMBO 13,7x24 cm 5 ³ / ₈ "x9 ⁷ / ₁₆ "	1069787 Rombo Black Storm 1069788 Rombo Cloud White 1069789 Rombo Grey Vetiver 1069791 Rombo Jewel 1069792 Rombo Metropolitan Grey 1069793 Rombo Navy Sea 1069794 Rombo North Pole	A28	60	0,97	20,50	56	54,32	1.164
 40x40 cm 16"x16"	1070805 Grey Vetiver 1070806 North Pole 1070807 Pink Velvet	A19	8	1,28	26,50	48	61,44	1.288
 MOSAICO ROMBO 25x25 cm 10"x10"	1069895 Mosaico Rombo Black Storm 1069896 Mosaico Rombo Cloud White 1069897 Mosaico Rombo Grey Vetiver 1069898 Mosaico Rombo Hunter Green 1069899 Mosaico Rombo Jewel 1069900 Mosaico Rombo Metropolitan Grey 1069901 Mosaico Rombo Navy Sea 1069902 Mosaico Rombo North Pole 1069903 Mosaico Rombo Pink Velvet 1069904 Mosaico Rombo Soft Mint	B18	5	0,30	7,00			
 MOSAICO ROMBO MIX 25x25 cm 10"x10"	1069905 Mosaico Rombo Mix Blue (Grey Vetiver, Metropolitan Grey, North Pole, Navy Sea) 1069906 Mosaico Rombo Mix Green (Grey Vetiver, Metropolitan Grey, Soft Mint, Hunter Green) 1069907 Mosaico Rombo Mix Grey (Cloud White, Grey Vetiver, Metropolitan Grey, Black Storm) 069908 Mosaico Rombo Mix Pink (Cloud White, Grey Vetiver, Pink Velvet, Jewel)	B20	5	0,30	7,00			

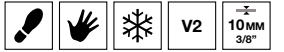
Gres fine porcellanato smaltato

Glazed fine porcelain stoneware . Grès cérame fin émaillé . Glasiertes Feinsteinzeug



FORMATO NOMINALE Nominal Size Format Nominal Nennformat	ARTICOLO Item Article Artikel	FASCE DI PREZZO Price ranges Groupes des prix Preisgruppen	BOX			PALLET		
			PEZZI Pieces Pièces Stücke	MQ Sqm Mc Qm	KG	SCATOLE Boxes Boîtes Kartons	MQ Sqm Mc Qm	KG
 MOSAICO ESAGONA 27x27 cm 10 ⁵ / ₈ "x10 ⁵ / ₈ "	1069909 Mosaico Esagona Black Storm 1069910 Mosaico Esagona Cloud White 1069911 Mosaico Esagona Grey Vetiver 1069912 Mosaico Esagona Hunter Green 1069913 Mosaico Esagona Jewel 1069914 Mosaico Esagona Metropolitan Grey 1069915 Mosaico Esagona Navy Sea 1069916 Mosaico Esagona North Pole 1069917 Mosaico Esagona Pink Velvet 1069918 Mosaico Esagona Soft Mint	B22	5	0,38	7,00			
 MOSAICO ESAGONA MIX 27x27 cm 10 ⁵ / ₈ "x10 ⁵ / ₈ "	1069919 Mosaico Esagona Mix Blue (Grey Vetiver, Metropolitan Grey, North Pole, Navy Sea) 1069920 Mosaico Esagona Mix Green (Cloud White, Grey Vetiver, Soft Mint, Hunter Green) 1069921 Mosaico Esagona Mix Grey (Cloud White, Grey Vetiver, Metropolitan Grey, Black Storm) 1069922 Mosaico Esagona Mix Pink (Cloud White, Grey Vetiver, Pink Velvet, Jewel)	B24	5	0,38	7,00			
 INSERTO NATURALE * 20x20 cm 8"x8"	1070833 Inserto Naturale S/4 Blue 1070835 Inserto Naturale S/4 Green 1070837 Inserto Naturale S/4 Grey 1070839 Inserto Naturale S/4 Red	B16	4	0,16	3,15			
 SIGARO 3x20 cm 1 ³ / ₁₆ "x8"	1070820 Sigaro Black Storm 1070821 Sigaro Cloud White 1070822 Sigaro Grey 1070824 Sigaro Hunter Green 1070823 Sigaro Jewel 1070825 Sigaro Metropolitan Grey 1070826 Sigaro Navy Sea 1070828 Sigaro North Pole 1070830 Sigaro Pink Velvet 1070831 Sigaro Soft Mint	B11	24		2,40			
 PROFILO 1,2x20 cm 1/2"x8"	1070193 Profilo Black Storm 1070194 Profilo Cloud White 1070195 Profilo Grey Vetiver 1070196 Profilo Hunter Green 1070818 Profilo Jewel 1070197 Profilo Metropolitan Grey 1070198 Profilo Navy Sea 1070199 Profilo North Pole 1070819 Profilo Pink Velvet 1070200 Profilo Soft Mint	B10	24		3,60			

* Decorì da rivestimento ad uso residenziale interno.

Wall decorations for interior residential.
Décor mural pour usage résidentiel intérieur.
Wanddekore nur für Innenbereich geeignet.



MIAMI



Miami Mix 20x20
White Rope 20x20
Light Brown 20x20



MIAMI

Colours

WHITE ROPE



DUST GREY

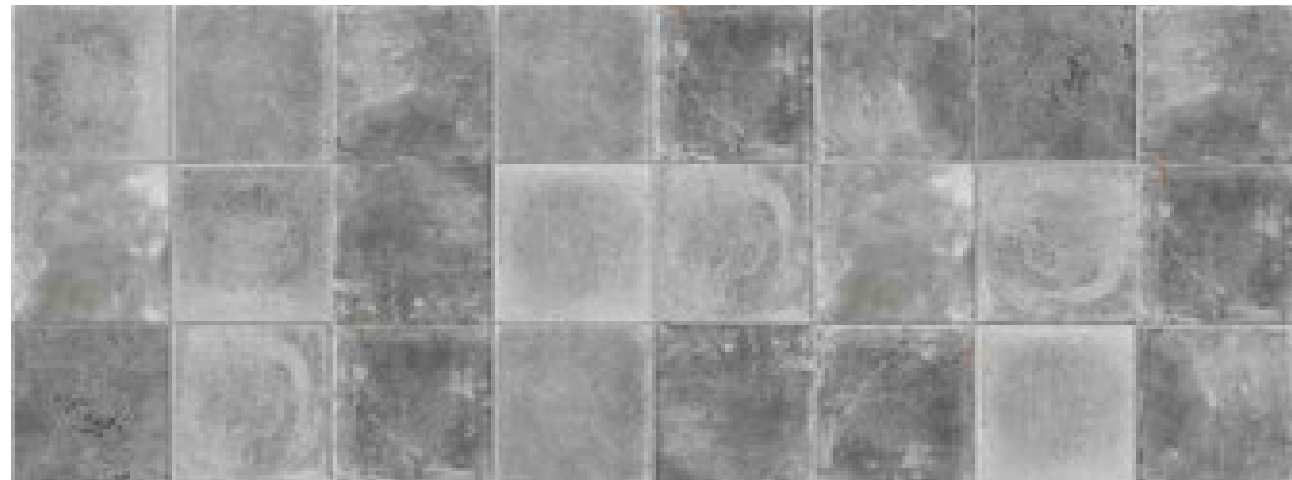

PITCH BLACK



Gres fine porcellanato smaltato

Glazed fine porcelain stoneware . Grès cérame fin émaillé . Glasiertes Feinsteinzeug



LIGHT BROWN



RED CLAY



GREEN BLUE



MIAMI

Colours

MIAMI MIX *



SOUTH BEACH

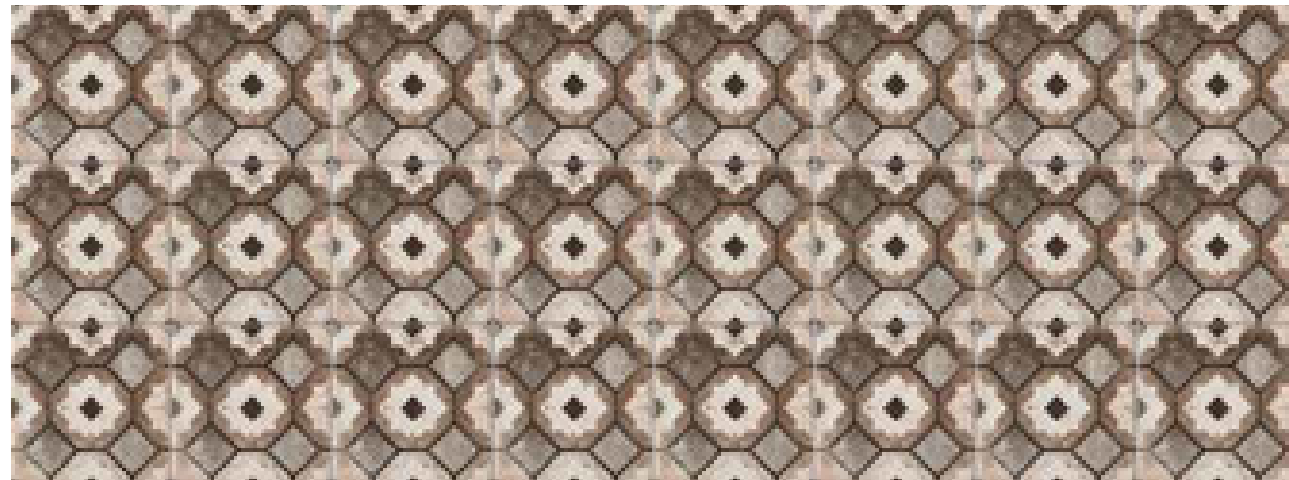

FISHER ISLAND

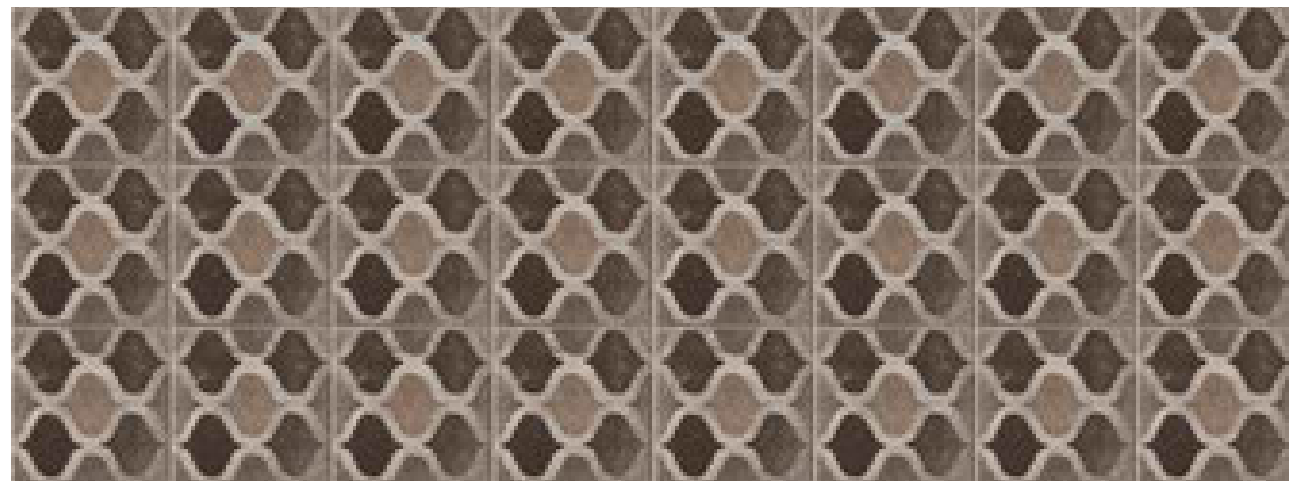









Gres fine porcellanato smaltato

Glazed fine porcelain stoneware . Grès cérame fin émaillé . Glasiertes Feinsteinzeug



Miami Mix Esagona 24x27,7





* 27/28 soggetti miscelati casualmente nelle scatole.
27/28 designs available with each box containing a random Mix.
27/28 motifs mélangés au hasard dans les boîtes.
Die 27/28 Muster in den Schachteln werden nach den Zufallsprinzip gemischt.

FORMATO NOMINALE Nominal Size Format Nominal Nennformat	ARTICOLO Item Article Artikel	FASCE DI PREZZO Price ranges Groupes des prix Preisgruppen	BOX			PALLET		
			PEZZI Pieces Pièces Stücke	MQ Sqm Mc Qm	KG	SCATOLE Boxes Boîtes Kartons	MQ Sqm Mc Qm	KG
 10x20 cm 4"x8"	1063965 Dust Grey 1063967 Light Brown 1063968 Pitch Black 1063970 White Rope	A11	36	0,72	14,20	72	51,84	1.040
	1063966 Green Blue 1063969 Red Clay	A13						
 20x20 cm 8"x8"	1063710 Dust Grey 1063712 Light Brown 1063708 Pitch Black 1063707 White Rope	A10	26	1,04	21,00	54	56,16	1.150
	1063709 Green Blue 1063711 Red Clay	A13						
 DEC MIX* 20x20 cm 8"x8"	1063713 Miami Mix	A19	26	1,04	21,00	54	56,16	1.150
 SOUTH BEACH 20x20 cm 8"x8"	1064711 South Beach	A19	26	1,04	21,00	54	56,16	1.150
 FISHER ISLAND 20x20 cm 8"x8"	1064709 Fisher Island	A19	26	1,04	21,00	54	56,16	1.150
 ESAGONA 24x27,7 cm 9 7/16"x10 7/8"	1063333 Esagona Dust Grey 1063335 Esagona Light Brown 1063331 Esagona Pitch Black 1063330 Esagona White Rope	A19	20	0,97	20,50	56	54,32	1.164
	1063332 Esagona Green Blue 1063334 Esagona Red Clay	A20A						
 MIAMI MIX ESAGONA* 24x27,7 cm 9 7/16"x10 7/8"	1063706 Esagona Miami Mix	A26A	20	0,97	20,50	56	54,32	1.164
 MOSAICO TESSERA 30x30 cm 12"x12" 2,2x2,2 cm 7/8"x2 1/8"	1064129 Mosaico Dust Grey 1064133 Mosaico Green Blue 1064131 Mosaico Light Brown 1064130 Mosaico Pitch Black 1064132 Mosaico Red Clay 1064128 Mosaico White Rope	B18	5	0,45	10,00			
 MOSAICO MIX COLOR 30x30 cm 12"x12" 2,2x2,2 cm 7/8"x2 1/8"	1064134 Mosaico Mix Color	B20	5	0,45	10,00			

Gres fine porcellanato smaltato

Glazed fine porcelain stoneware . Grès cérame fin émaillé . Glasiertes Feinsteinzeug



FORMATO NOMINALE Nominal Size Format Nominal Nennformat	ARTICOLO Item Article Artikel	FASCE DI PREZZO Price ranges Groupes des prix Preisgruppen	BOX			PALLET		
			PEZZI Pieces Pièces Stücke	MQ Sqm Mc Qm	KG	SCATOLE Boxes Boîtes Kartons	MQ Sqm Mc Qm	KG
 OCEAN DRIVE ** 20x20 cm 8"x8"	1064144 Ocean Drive S/6	B16	6	0,24	4,80			
 CORAL GABLES ** 20x20 cm 8"x8"	1064146 Coral Gables S/8	B16	8	0,32	6,40			
 COLLINS ESAGONA ** 24x27,7 cm 9 7/16"x10 7/8"	1064136 Esagona Collins Blue S/6 1064135 Esagona Collins Red S/6	B18	6	0,291	6,00			
 FLORIDA ESAGONA ** 24x27,7 cm 9 7/16"x10 7/8"	1064138 Esagona Florida Blue S/6 1064137 Esagona Florida Grey S/6	B18	6	0,291	6,00			
 ELEMENTO AD "L" 10x4x15 cm 4"x1 1/16"x6"	1064117 Dust Grey 1064119 Light Brown 1064118 Pitch Black 1064116 White Rope	B10	10		3,20			

* Soggetti miscelati casualmente nelle scatole.

Designs available with each box containing a random Mix.
Motifs mélangés au hasard dans les boîtes.
Die Muster in den Schachteln werden nach den Zufallsprinzip gemischt.

** Decorì da rivestimento ad uso residenziale interno.

Wall decorations for interior residential.
Décor mural pour usage résidentiel intérieur.
Wanddekore nur für Innenbereich geeignet.



MOLO AUDACE





MOLO AUDACE

Colours

GRIGIO DI SCOTTA



BOCCA DI LUPO



NERO GALERA



Gres fine porcellanato smaltato

Glazed fine porcelain stoneware . Grès cérame fin émaillé . Glasiertes Feinsteinzeug



BITTA DI PORTO



TERRA D'ORMEGGIO



ROSSO D'AMANTE



MOLO AUDACE

Colours

MOLO MIX NERO *

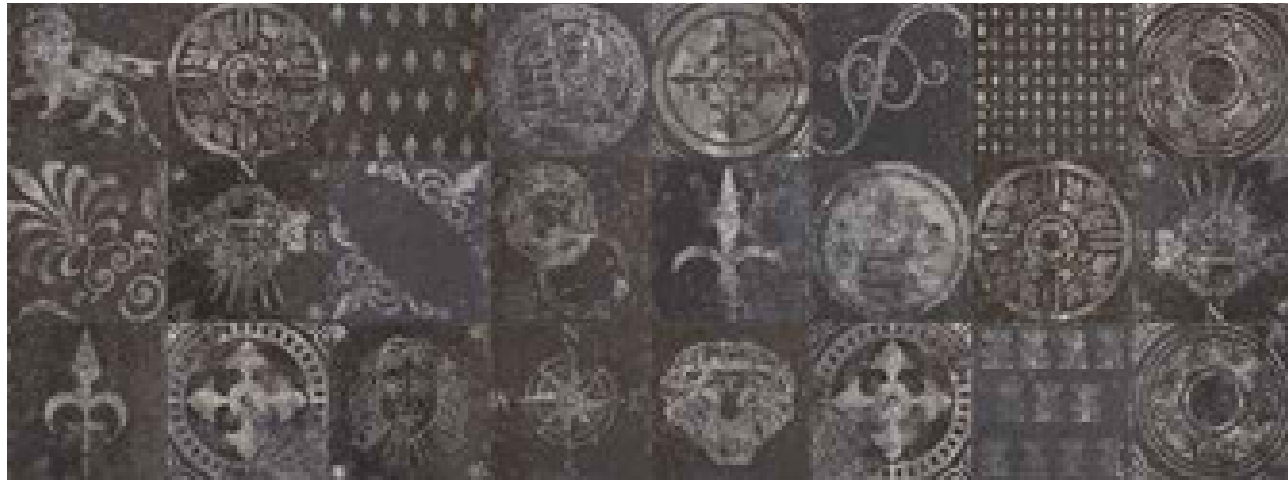

MOLO MIX ROSSO *

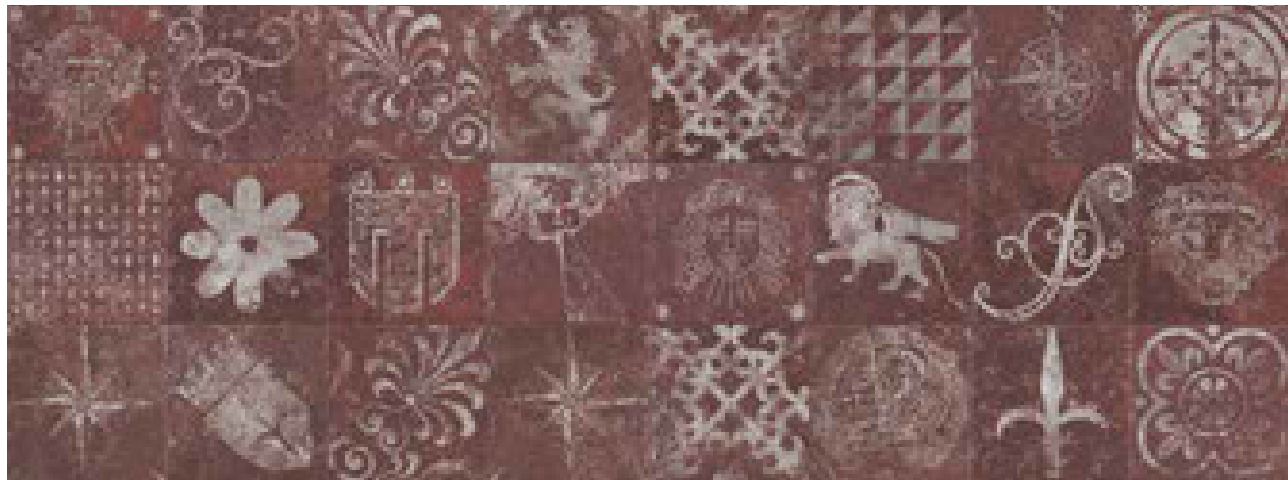

* 33 soggetti miscelati casualmente nelle scatole.
33 designs available with each box containing a random mix.
33 motifs mélangés au hasard dans les boîtes.
Die 33 Muster in den Schachteln werden nach dem Zufallsprinzip gemischt.

Gres fine porcellanato smaltato

Glazed fine porcelain stoneware . Grès cérame fin émaillé . Glasiertes Feinsteinzeug









Molo mix Rosso 20x20



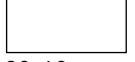

MOLO AUDACE

Gres fine porcellanato smaltato

Glazed fine porcelain stoneware . Grès cérame fin émaillé . Glasiertes Feinsteinzeug

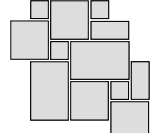
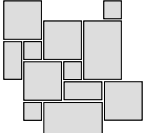

FORMATO NOMINALE Nominal Size Format Nominal Nennformat	ARTICOLO Item Article Artikel	FASCE DI PREZZO Price ranges Groupes des prix Preisgruppen	BOX			PALLET		
			PEZZI Pieces Pièces Stücke	MQ Sqm Mc Qm	KG	SCATOLE Boxes Boîtes Kartons	MQ Sqm Mc Qm	KG
 20x20 cm 8"x8"	1067969 Bitta di Porto 1067968 Bocca di Lupo 1067970 Grigio di Scotta 1067973 Terra d'Ormezzio	A10	26	1,04	21,00	54	56,16	1.150
	1067971 Nero Galera 1067972 Rosso d'Amante	A11						
 MOLO MIX* 20x20 cm 8"x8"	1068096 Molo Mix Nero 1068097 Molo Mix Rosso	A19	26	1,04	21,00	54	56,16	1.150
 20x20 cm 8"x8" R11	1068507 Bitta di Porto 1068508 Bocca di Lupo 1068509 Grigio di Scotta 1068512 Terra d'Ormezzio	A11	26	1,04	21,00	54	56,16	1.150
	1068510 Nero Galera 1068511 Rosso d'Amante	A13						
 20x40 cm 8"x16"	1067975 Bitta di Porto 1067974 Bocca di Lupo 1067976 Grigio di Scotta 1067979 Terra d'Ormezzio	A10	13	1,04	21,10	54	56,16	1.154
	1067977 Nero Galera 1067978 Rosso d'Amante	A11						
 20x40 cm 8"x16" R11	1068513 Bitta di Porto 1068514 Bocca di Lupo 1068515 Grigio di Scotta 1068518 Terra d'Ormezzio	A11	13	1,04	21,10	54	56,16	1.154
	1068516 Nero Galera 1068517 Rosso d'Amante	A13						
 40x40 cm 16"x16"	1067981 Bitta di Porto 1067980 Bocca di Lupo 1067982 Grigio di Scotta 1067985 Terra d'Ormezzio	A10	8	1,28	26,50	48	61,44	1.288
	1067983 Nero Galera 1067984 Rosso d'Amante	A11						
 40x40 cm 16"x16" R11	1068519 Bitta di Porto 1068520 Bocca di Lupo 1068521 Grigio di Scotta 1068524 Terra d'Ormezzio	A11	8	1,28	26,50	48	61,44	1.288
	1068522 Nero Galera 1068523 Rosso d'Amante	A13						
 40x60,8 cm 16"x24"	1067987 Bitta di Porto 1067986 Bocca di Lupo 1067988 Grigio di Scotta 1067991 Terra d'Ormezzio	A11	4	0,97	20,00	60	58,20	1.216
	1067989 Nero Galera 1067990 Rosso d'Amante	A13						
 40x60,8 cm 16"x24" R11	1068525 Bitta di Porto 1068526 Bocca di Lupo 1068527 Grigio di Scotta 1068530 Terra d'Ormezzio	A13	4	0,97	20,00	60	58,20	1.216
	1068528 Nero Galera 1068529 Rosso d'Amante	A15						

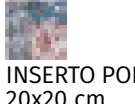
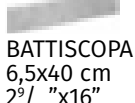
FORMATO NOMINALE Nominal Size Format Nominal Nennformat	ARTICOLO Item Article Artikel	FASCE DI PREZZO Price ranges Groupes des prix Preisgruppen	BOX			PALLET		
			PEZZI Pieces Pièces Stücke	MQ Sqm Mc Qm	KG	SCATOLE Boxes Boîtes Kartons	MQ Sqm Mc Qm	KG
 MODULARE 39 ***	1068543 Bitta di Porto 1068544 Bocca di Lupo 1068545 Grigio di Scotta 1068548 Terra d'Ormezzio	A20A	6	0,723	16,00	40	28,92	656
	1068546 Nero Galera 1068547 Rosso d'Amante	A22						
 MODULARE 39 R11 ***	1068569 Bitta di Porto 1068570 Bocca di Lupo 1068571 Grigio di Scotta 1068574 Terra d'Ormezzio	A22	6	0,723	16,00	40	28,92	656
	1068572 Nero Galera 1068573 Rosso d'Amante	A23						
Contenuto di una scatola One box contents Contenu d'une boîte Inhalt einer Schachtel	20x40 - 8"x16": 1 pc 40x40 - 16"x16": 2 pc 20x20 - 8"x8": 2 pc 40x60,8 - 16"x24": 1 pc							
 MOSAICO PAVÈ 30x30 cm 12"x12"	1068394 Mosaico Pavè Bitta di Porto 1068396 Mosaico Pavè Bocca di Lupo 1068397 Mosaico Pavè Grigio di Scotta 1068398 Mosaico Pavè Terra d'Ormezzio	B14	5	0,45	10,00			
	1068399 Mosaico Pavè Mix Nero 1068400 Mosaico Pavè Mix Rosso	B15	5	0,45	10,00			
 MOSAICO PAVÈ MIX 30x30 cm 12"x12"	1069934 Insetto Porto Vecchio S/6	B16	6	0,24	5,50			
 BATTISCOPA 6,5x40 cm 2 9/16 "x16"	1069651 Bitta di Porto 1069652 Bocca di Lupo 1069653 Grigio di Scotta 1069654 Nero Galera 1069655 Rosso d'Amante 1069656 Terra d'Ormezzio	C3	20	ml 8,00	11,00			
 ELEMENTO AD "L" MONOLITICO R11 10x40x4 4"x16"x1 9/16"	1069663 Bitta di Porto 1069664 Bocca di Lupo 1069665 Grigio di Scotta 1069666 Nero Galera 1069667 Rosso d'Amante 1069668 Terra d'Ormezzio	B24	8		9,20			

*** Soggetti miscelati casualmente nelle scatole.**

Designs available with each box containing a random mix.
Motifs mélangés au hasard dans les boîtes.
Die Muster in den Schachteln werden nach den Zufallsprinzip gemischt.

**** Decorì da rivestimento ad uso residenziale interno.**

Wall decorations for interior residential.
Décor mural pour usage résidentiel intérieur.
Wanddekore nur für Innenbereich geeignet.

*** LA POSA MODULARE È CONSIGLIATA CON UNA FUGA DI 4-5 MM. - WE RECOMMEND MODULAR LAYING WITH A 4-5 MM ^{3/16} JOINT.
LA POSE MODULAIRE EST CALCULÉE AVEC UN JOINT DE 4-5 MM. - DIE MODULVERLEGUNG WIRD MIT EINER MINDESTFUGE VON 4-5 MM EMPFOHLEN.



NEW ORLEANS





NEW ORLEANS

Colours

BOURBON STREET



ROYAL STREET



Gres fine porcellanato smaltato

Glazed fine porcelain stoneware . Grès cérame fin émaillé . Glasiertes Feinsteinzeug



FRENCH QUARTER BOURBON *



FRENCH QUARTER ROYAL *



* 20 soggetti miscelati casualmente nelle scatole.

20 designs available with each box containing a random mix.

20 motifs mélangés au hasard dans les boîtes.







Die 20 Muster in den Schachteln werden nach dem Zufallsprinzip gemischt.

NEW ORLEANS

Gres fine porcellanato smaltato

Glazed fine porcelain stoneware . Grès cérame fin émaillé . Glasiertes Feinsteinzeug



FORMATO NOMINALE Nominal Size Format Nominal Nennformat	ARTICOLO Item Article Artikel	FASCE DI PREZZO Price ranges Groupes des prix Preisgruppen	BOX			PALLET		
			PEZZI Pieces Pièces Stücke	MQ Sqm Mc Qm	KG	SCATOLE Boxes Boîtes Kartons	MQ Sqm Mc Qm	KG
 20x20 cm 8"x8"	1049582 Bourbon Street 1049607 Royal Street	A10	24	0,96	19,50	54	51,84	1.070
 FRENCH QUARTER MIX* 20x20 cm 8"x8"	1049585 French Quarter Bourbon Mix 1049586 French Quarter Royal Mix	A19	24	0,96	19,50	54	51,84	1.070
 ESAGONA 24x27,7 cm 9 7/16"x10 7/8"	1049597 Esagona Bourbon Street 1049609 Esagona Royal Street	A19	20	0,97	20,50	56	54,32	1.164
 FRENCH QUARTER ESAGONA MIX * 24x27,7 cm 9 7/16"x10 7/8"	1049600 Esagona French Quarter Bourbon Mix 1049601 Esagona French Quarter Royal Mix	A26A	20	0,97	20,50	56	54,32	1.164
 INSERTO MARDI GRAS ** 20x20 cm 8"x8"	1049655 Inserto Mardi Gras S/6	B16	6					
 MARDI GRAS ESAGONA ** 24x27,7 cm 9 7/16"x10 7/8"	1049660 Esagona Mardi Gras S/6	B18	6					

* Soggetti miscelati casualmente nelle scatole.

Designs available with each box containing a random mix.
Motifs mélangés au hasard dans les boîtes.
Die Muster in den Schachteln werden nach den Zufallsprinzip gemischt.

** Decori da rivestimento ad uso residenziale interno.

Wall decorations for interior residential.
Décor mural pour usage résidentiel intérieur.
Wanddekore nur für Innenbereich geeignet.



Royal Street 20x20
Inserto Mardi Gras S/6 20x20

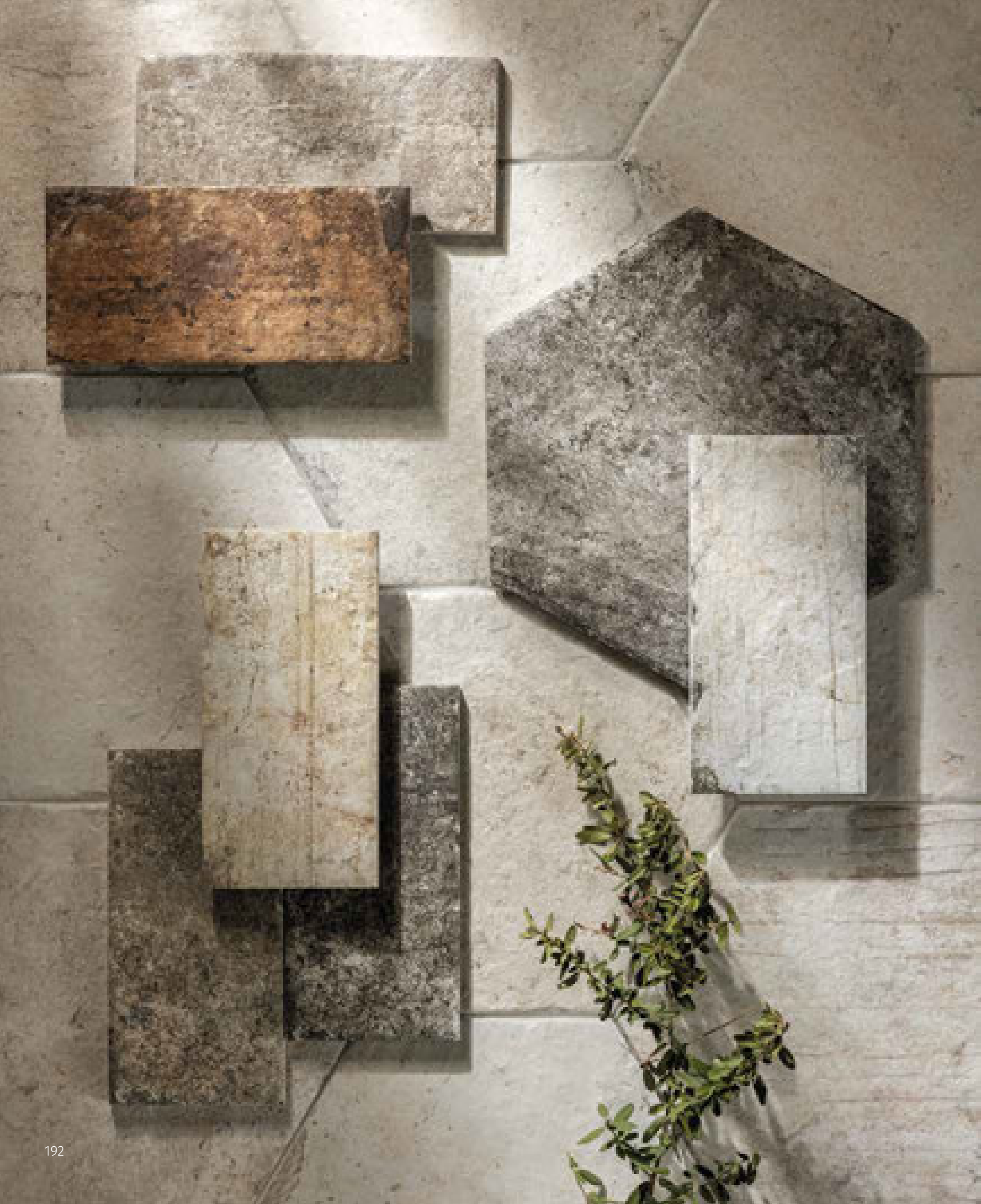

NEW YORK

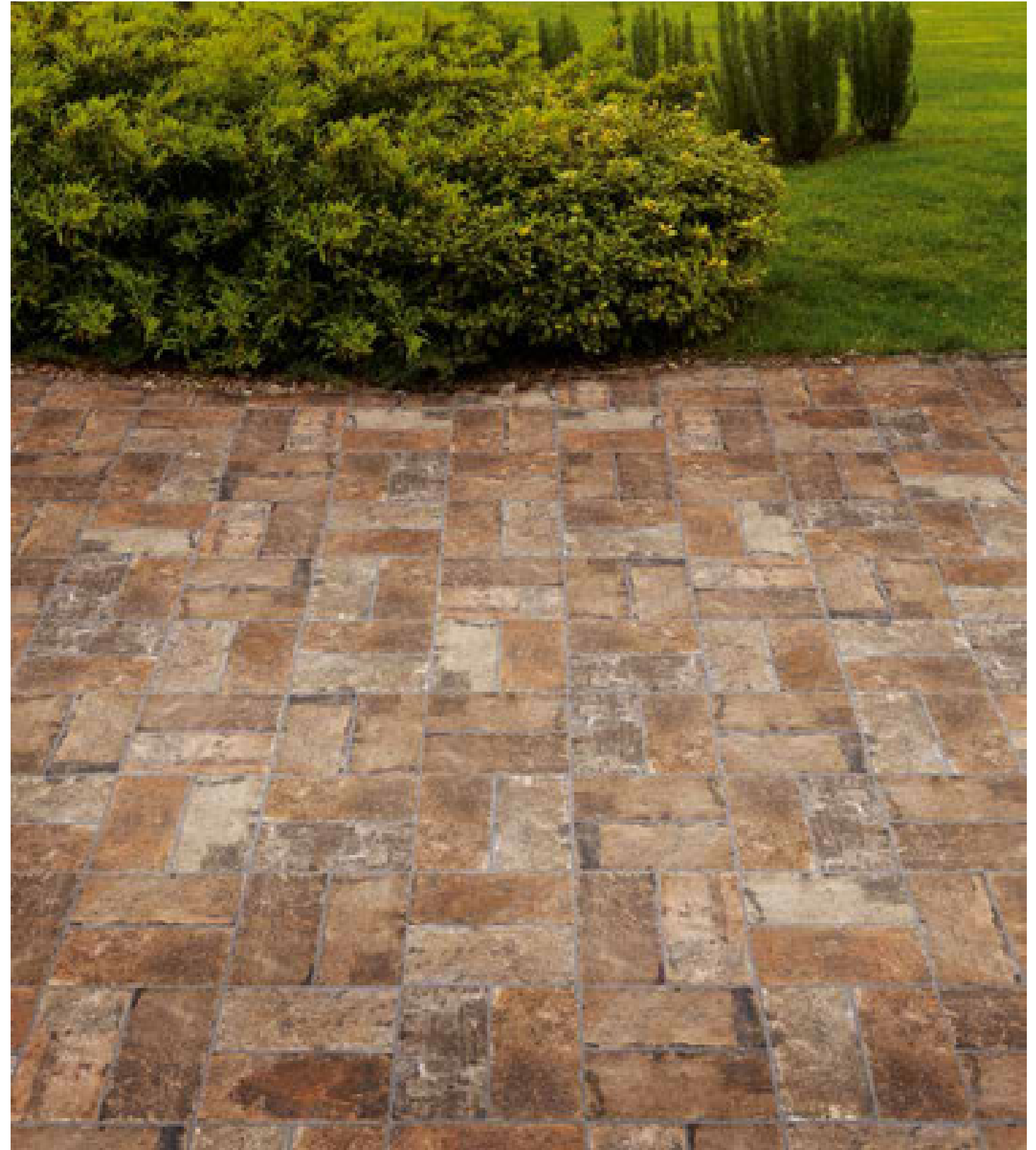



NEW YORK

Colours

GREENWICH VILLAGE



SOHO



WALL STREET



Gres fine porcellanato smaltato

Glazed fine porcelain stoneware . Grès cérame fin émaillé . Glasiertes Feinsteinzeug



BROADWAY



CHELSEA

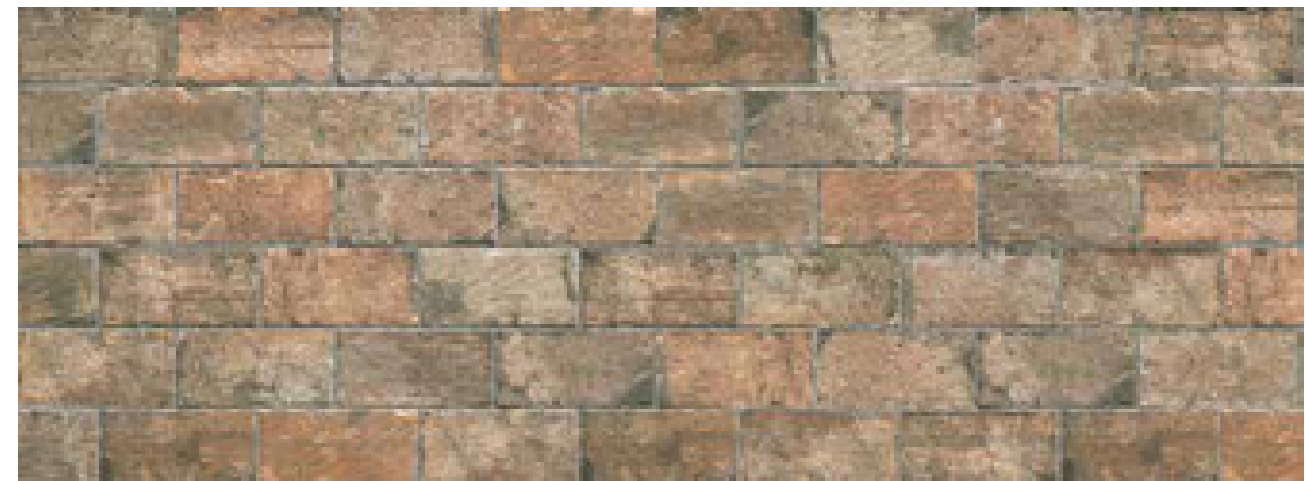

CENTRAL PARK

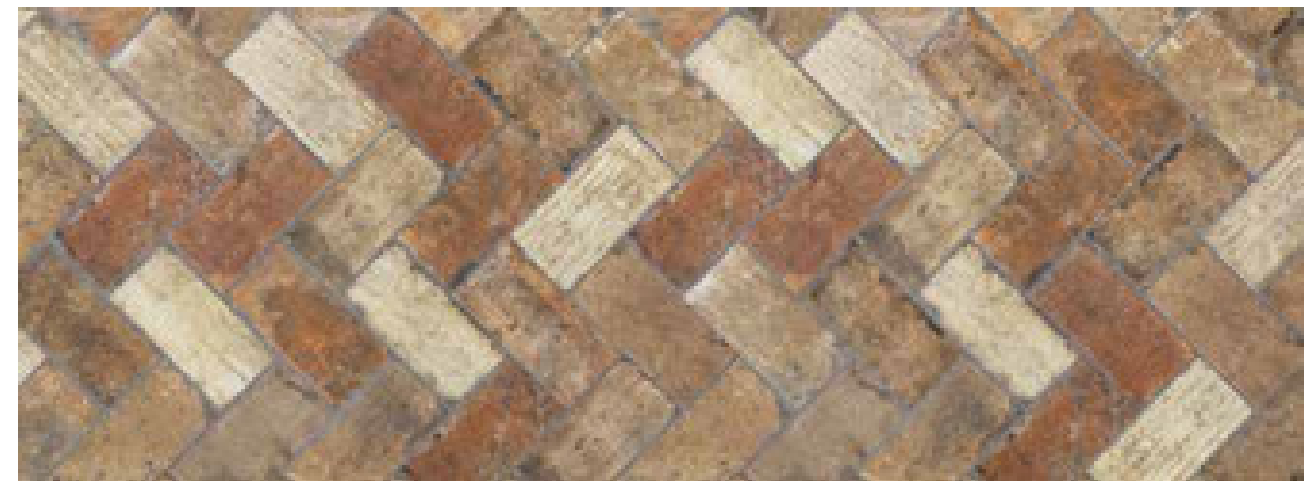

NEW YORK

Colours

ROAD SIGNS MIX *



FORMATO NOMINALE Nominal Size Format Nominal Nennformat	ARTICOLO Item Article Artikel	FASCE DI PREZZO Price ranges Groupes des prix Preisgruppen	BOX			PALLET		
			PEZZI Pieces Pièces Stücke	MQ Sqm Mc Qm	KG	SCATOLE Boxes Boîtes Kartons	MQ Sqm Mc Qm	KG
 10x20 cm 4"x8"	1048153 Broadway 1048154 Central Park 1048155 Chelsea 1048156 Greenwich Village 1048157 Soho 1048158 Wall Street	A11	34	0,68	14,50	72	48,96	1.060
 ROAD SIGNS MIX * 10x20 cm 4"x8"	1048422 Road Signs Central Park 1048423 Road Signs Chelsea 1048424 Road Signs Greenwich Village 1048425 Road Signs Soho 1048426 Road Signs Wall Street	A20A	34	0,68	14,50	72	48,96	1.060
 ESAGONA 24x27,7 cm 9 7/16"x10 7/8"	1048413 Esagona Broadway 1048414 Esagona Central Park 1048415 Esagona Chelsea 1048416 Esagona Greenwich Village 1048417 Esagona Soho 1048418 Esagona Wall Street	A19	20	0,97	20,50	56	54,32	1.164

* 26 soggetti miscelati casualmente nelle scatole.
26 designs available with each box containing a random mix.
26 motifs mélangés au hasard dans les boîtes.
Die 26 Muster in den Schachteln werden nach dem Zufallsprinzip gemischt.

Gres fine porcellanato smaltato

Glazed fine porcelain stoneware . Grès cérame fin émaillé . Glasiertes Feinsteinzeug



Wall Street 10x20



REGGIO NELL'EMILIA





REGGIO NELL'EMILIA

Colours

BROLETTO



ROSTA NUOVA



DUE MAESTÀ



Gres fine porcellanato smaltato

Glazed fine porcelain stoneware . Grès cérame fin émaillé . Glasiertes Feinsteinzeug



PIEVE



REGGIO NELL'EMILIA

Colours

DEC MIX BROLETTO *



DEC MIX ROSTA NUOVA *



DEC MIX DUE MAESTÀ *



Gres fine porcellanato smaltato

Glazed fine porcelain stoneware . Grès cérame fin émaillé . Glasiertes Feinsteinzeug



DEC MIX PIEVE *

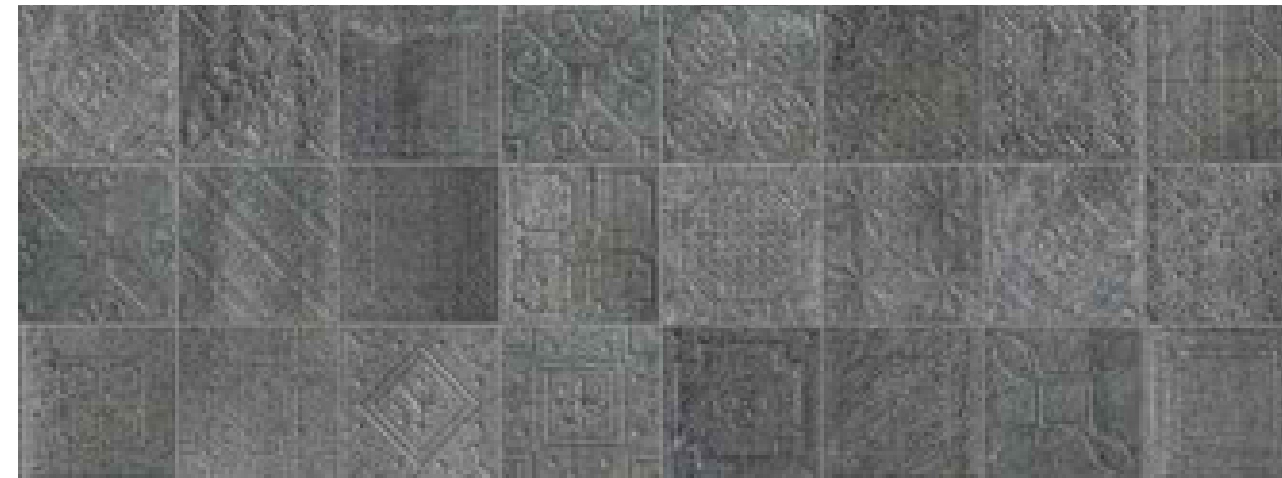







* 23 soggetti miscelati casualmente nelle scatole.

23 designs available with each box containing a random mix.

23 motifs mélangés au hasard dans les boîtes.

Die 23 Muster in den Schachteln werden nach dem Zufallsprinzip gemischt.

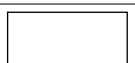
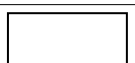
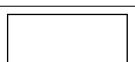
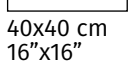

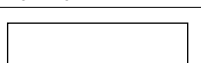

REGGIO NELL'EMILIA

FORMATO NOMINALE Nominal Size Format Nominal Nennformat	ARTICOLO Item Article Artikel	FASCE DI PREZZO Price ranges Groupes des prix Preisgruppen	BOX			PALLET		
			PEZZI Pieces Pièces Stücke	MQ Sqm Mc Qm	KG	SCATOLE Boxes Boîtes Kartons	MQ Sqm Mc Qm	KG
 20x20 cm 8"x8"	1060186 Broletto 1059361 Due Maestà 1059362 Pieve 1059363 Rosta Nuova	A10	26	1,04	21,00	54	56,16	1.150
 DEC MIX* 20x20 cm 8"x8"	1060206 Dec Mix Broletto 1060207 Dec Mix Due Maestà 1060208 Dec Mix Pieve 1060209 Dec Mix Rosta Nuova	A19	26	1,04	21,00	54	56,16	1.150
 20x20 cm 8"x8" R11	1060187 Broletto 1060183 Due Maestà 1060184 Pieve 1060185 Rosta Nuova	A11	26	1,04	21,00	54	56,16	1.150
 20x40 cm 8"x16"	1060188 Broletto 1059356 Due Maestà 1059357 Pieve 1059358 Rosta Nuova	A10	13	1,04	21,10	54	56,16	1.154
 20x40 cm 8"x16" R11	1060189 Broletto 1060192 Due Maestà 1060193 Pieve 1060194 Rosta Nuova	A11	13	1,04	21,10	54	56,16	1.154
 20x40 cm 8"x16" R11 15 mm	1060437 Broletto R11 15 mm 1059372 Due Maestà R11 15 mm 1059373 Pieve R11 15 mm 1059374 Rosta Nuova R11 15 mm	A22A	8	0,64	19,50	54	34,56	1.069
 40x40 cm 16"x16"	1060190 Broletto 1059349 Due Maestà 1059350 Pieve 1059351 Rosta Nuova	A10	8	1,28	26,50	48	61,44	1.288
 40x40 cm 16"x16" R11	1060191 Broletto 1060195 Due Maestà 1060196 Pieve 1060197 Rosta Nuova	A11	8	1,28	26,50	48	61,44	1.288
 40x60,8 cm 16"x24"	1060198 Broletto 1060200 Due Maestà 1060202 Pieve 1060204 Rosta Nuova	A11	4	0,97	20,00	60	58,20	1.216
 40x60,8 cm 16"x24" R11	1062600 Broletto 1062601 Due Maestà 1062602 Pieve 1062603 Rosta Nuova	A13	4	0,97	20,00	60	58,20	1.216

Gres fine porcellanato smaltato

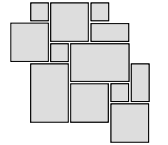
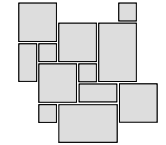
Glazed fine porcelain stoneware . Grès cérame fin émaillé . Glasiertes Feinsteinzeug



FORMATO NOMINALE Nominal Size Format Nominal Nennformat	ARTICOLO Item Article Artikel	FASCE DI PREZZO Price ranges Groupes des prix Preisgruppen	BOX			PALLET		
			PEZZI Pieces Pièces Stücke	MQ Sqm Mc Qm	KG	SCATOLE Boxes Boîtes Kartons	MQ Sqm Mc Qm	KG
 MODULARE 39 **	1070549 Broletto 1070550 Due Maestà 1070551 Pieve 1070552 Rosta Nuova	A20A	6	0,723	16,00	40	28,92	656
 MODULARE 39 R11 **	1070553 Broletto 1070554 Due Maestà 1070555 Pieve Modulo 1070556 Rosta Nuova	A22	6	0,723	16,00	40	28,92	656
Contenuto di una scatola One box contents Contenu d'une boîte Inhalt einer Schachtel	20x40 - 8"x16": 1 pc 40x40 - 16"x16": 2 pc 20x20 - 8"x8": 2 pc 40x60,8 - 16"x24": 1 pc							
 MOSAICO PAVÈ 30x30 cm 12"x12"	1061328 Mosaico Pavè Broletto 1059704 Mosaico Pavè Due Maestà 1059705 Mosaico Pavè Pieve 1059706 Mosaico Pavè Rosta Nuova	B14	5	0,45	10,00			
 MOSAICO VENTAGLIO 75x52 cm 29 ¹ / ₂ "x20 ¹ / ₂ " (1 mq = 4,35 pz.)	1061329 Mosaico Ventaglio Broletto 1059697 Mosaico Ventaglio Due Maestà 1059698 Mosaico Ventaglio Pieve 1059699 Mosaico Ventaglio Rosta Nuova	B35	3	0,69	15,00			
 BATTISCOPA 6,5x40 cm 2 ⁹ / ₁₆ "x16"	1061668 Broletto 1060051 Due Maestà 1060052 Pieve 1060053 Rosta Nuova	C3	20	ml 8,00	11,00			
 ELEMENTO AD "L" MONOLITICO R11 10x40x4 4"x16"x1 ⁹ / ₁₆ "	1061334 Broletto 1061331 Due Maestà 1061330 Pieve 1061332 Rosta Nuova	B24	8		9,20			

* **Soggetti miscelati casualmente nelle scatole.**

Designs available with each box containing a random mix.
Motifs mélangés au hasard dans les boîtes.

Die Muster in den Schachteln werden nach den Zufallsprinzip gemischt.

** LA POSA MODULARE È CONSIGLIATA CON UNA FUGA DI 4-5 MM. - WE RECOMMEND MODULAR LAYING WITH A 4-5 MM ³/₁₆ JOINT.
LA POSE MODULAIRE EST CALCULÉE AVEC UN JOINT DE 4-5 MM. - DIE MODULVERLEGUNG WIRD MIT EINER MINDESTFUGE VON 4-5 MM EMPFOHLEN.

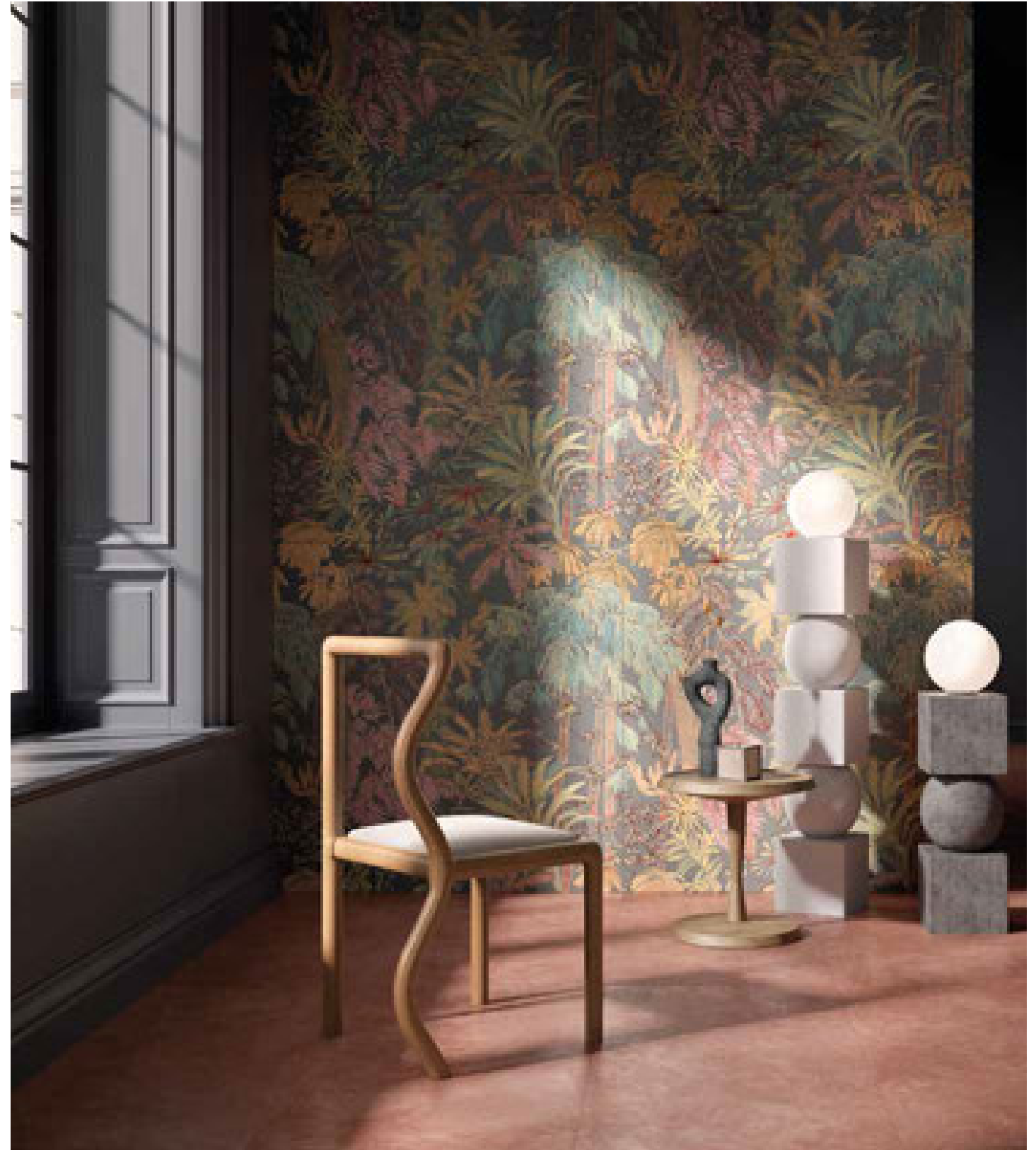

Savannah Wall 27 (comp 2 pz) 120x120 rett
Serenissima Studio 50 Peltro 60x120 rett



SHOWALL

Decorì da rivestimento ad uso residenziale interno.
 Wall decorations for interior residential.
 D cor mural pour usage r sidentiel int rieur.
 Wanddekore nur f r Innenbereich geeignet.

Gres fine porcellanato smaltato
 Glazed fine porcelain stoneware
 Gr s c r me fin  maill e
 Glasiertes Feinsteinzeug



BOX		
PZ	SQM	KGS
comp 1	1,44	31,00

Black Leaf Wall06



A
1069819
 comp 2 PZ 120x120 . 48"x48" rett
 ● **B72**

B

Garden Wall08



A
1069823
 comp 2 PZ 120x120 . 48"x48" rett
 ● **B67**

B

White Leaf Wall07



A
1069821
 comp 2 PZ 120x120 . 48"x48" rett
 ● **B68**

B

Jungle Wall09



A
1069825
 comp 2 PZ 120x120 . 48"x48" rett
 ● **B68**

B

SHOWALL

Decorì da rivestimento ad uso residenziale interno.
 Wall decorations for interior residential.
 D cor mural pour usage r sidentiel int rieur.
 Wanddekore nur f r Innenbereich geeignet.

Gres fine porcellanato smaltato
 Glazed fine porcelain stoneware
 Gr s c r me fin  mail l e
 Glasiertes Feinsteinzeug



BOX		
PZ	SQM	KGS
comp 1	1,44	31,00

Fenice Wall13



A
1070292
 comp 2 PZ 120x120 . 48"x48" rett
 ● **B68C**

B

Monkey Wall15



A
1070301
 comp 2 PZ 120x120 . 48"x48" rett
 ● **B68**

B

Forest Wall14



A
1070296
 comp 2 PZ 120x120 . 48"x48" rett
 ● **B68**

B

Palm Beach Wall17



A
1074003
 comp 2 PZ 120x120 . 48"x48" rett
 ● **B68C**

B

SHOWALL

Decorì da rivestimento ad uso residenziale interno.
Wall decorations for interior residential.
D cor mural pour usage r sidentiel int rieur.
Wanddekore nur f r Innenbereich geeignet.

Gres fine porcellanato smaltato
Glazed fine porcelain stoneware
Gr s c r me fin  maill e
Glasiertes Feinsteinzeug



BOX		
PZ	SQM	KGS
comp 1	1,44	31,00

Amazzonia Blu Wall18



A
1074004
comp 2 PZ 120x120 . 48"x48" rett
● B72

B

Oasi Wall26

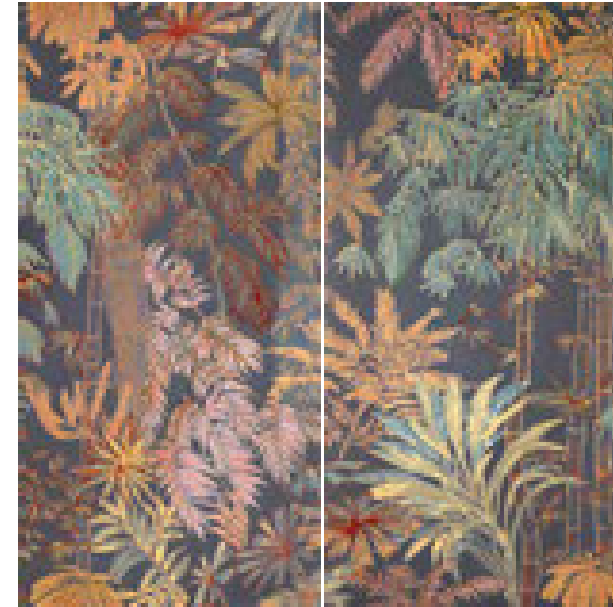

A
1082056
comp 2 PZ 120x120 . 48"x48" rett
● B68C

B

Deserto Wall25



A
1082055
comp 2 PZ 120x120 . 48"x48" rett
● B68A

B

Savannah Wall27



A
1082057
comp 2 PZ 120x120 . 48"x48" rett
● B68C

B

SHOWALL

Decorì da rivestimento ad uso residenziale interno.
Wall decorations for interior residential.
D cor mural pour usage r sidentiel int rieur.
Wanddekore nur f r Innenbereich geeignet.

Gres fine porcellanato smaltato
Glazed fine porcelain stoneware
Gr s c rame fin  maill e
Glasiertes Feinsteinzeug



BOX		
PZ	SQM	KGS
comp 1	1,44	31,00

Tropical Wall28



A
1082058
comp 2 PZ 120x120 . 48"x48" rett
● **B68A**

B

Ninfa Wall31



A
1082680
comp 2 PZ 120x120 . 48"x48" rett
● **B68C**

B

Poppy Wall30



A
1082060
comp 2 PZ 120x120 . 48"x48" rett
● **B68A**

B

Afrodite Wall32



A
1082681
comp 2 PZ 120x120 . 48"x48" rett
● **B68C**

B

SHOWALL

Decorì da rivestimento ad uso residenziale interno.
 Wall decorations for interior residential.
 D cor mural pour usage r sidentiel int rieur.
 Wanddekore nur f r Innenbereich geeignet.

Gres fine porcellanato smaltato
 Glazed fine porcelain stoneware
 Gr s c r me fin  mail l e
 Glasiertes Feinsteinzeug



BOX		
PZ	SQM	KGS
comp 1	1,44	31,00

Odalisca Wall22



1074008 comp 2 pz
 60x240 . 24"x96" rett
 ● **B72**

INFORMAZIONI COMPOSIZIONI A DUE PEZZI

INFORMATION REGARDING TWO-PIECE COMPOSITIONS . INFORMATIONS SUR LES COMPOSITIONS EN DEUX PI CES
 ANGABEN ZWEIST CKKOMBINATIONEN



Controllare il numero di composizioni necessarie per completare correttamente il disegno: gli elementi si devono raccordare sia in orizzontale che verticale. Nel caso illustrato, sono necessarie 4 composizioni, non 3.

Check the number of compositions needed in order to complete the design correctly: the elements must be match up both horizontally and vertically. In the case shown, 4 compositions are needed, not 3.

V rifier le nombre de compositions n cessaires pour compl ter correctement le dessin : les  l ments doivent co ncider aussi bien horizontalement que verticalement. Dans le cas illustr , les compositions n cessaires sont au nombre de 4 et non de 3.

Die Anzahl der Zusammenstellungen pr fen, die zur korrekten Vervollst ndigung der Zeichnung n tig sind: Die Elemente m ssen sich sowohl waagerecht als auch senkrecht miteinander verbinden. Im dargestellten Beispiel sind nicht 3, sondern 4 Zusammenstellungen n tig.



SHOWALL

Decorati da rivestimento ad uso residenziale interno.
 Wall decorations for interior residential.
 Décor mural pour usage résidentiel intérieur.
 Wanddekore nur für Innenbereich geeignet.

Gres fine porcellanato smaltato
 Glazed fine porcelain stoneware
 Grès cérame fin émaillé
 Glasiertes Feinsteinzeug



PICS AND STORIES
 FROM THIS COLLECTION
SMART GALLERY



9,5 MM
 3/8"

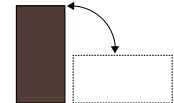

BOX		
PZ	SQM	KGS
2	1,44	31,00

Art Deco Wall01



1069815
 60x120 . 24"x48" rett
 ● **B62C**

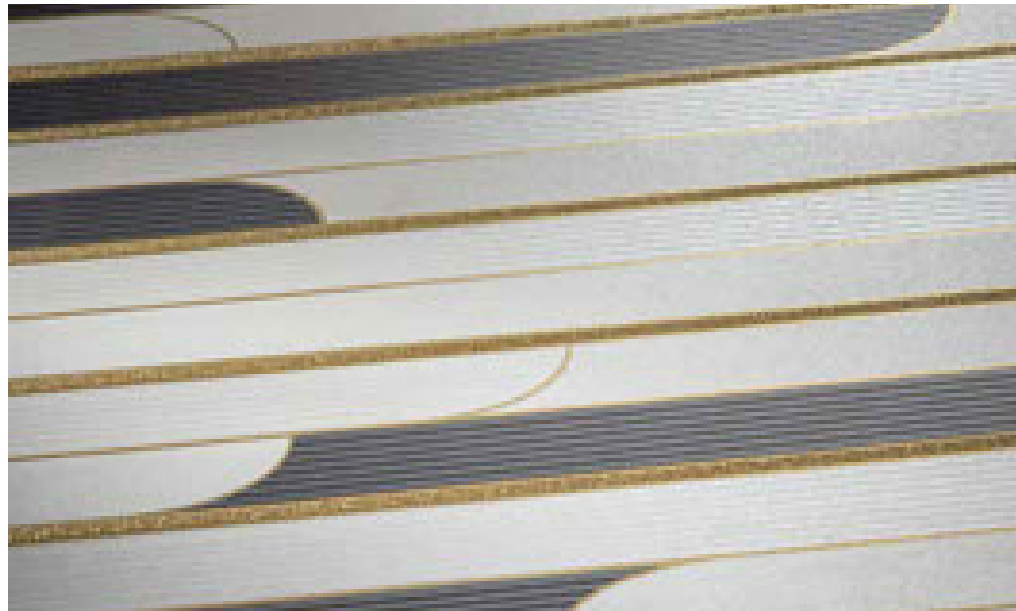

Myfair White Wall03



1070217
 60x120 . 24"x48" rett
 ● **B62C**

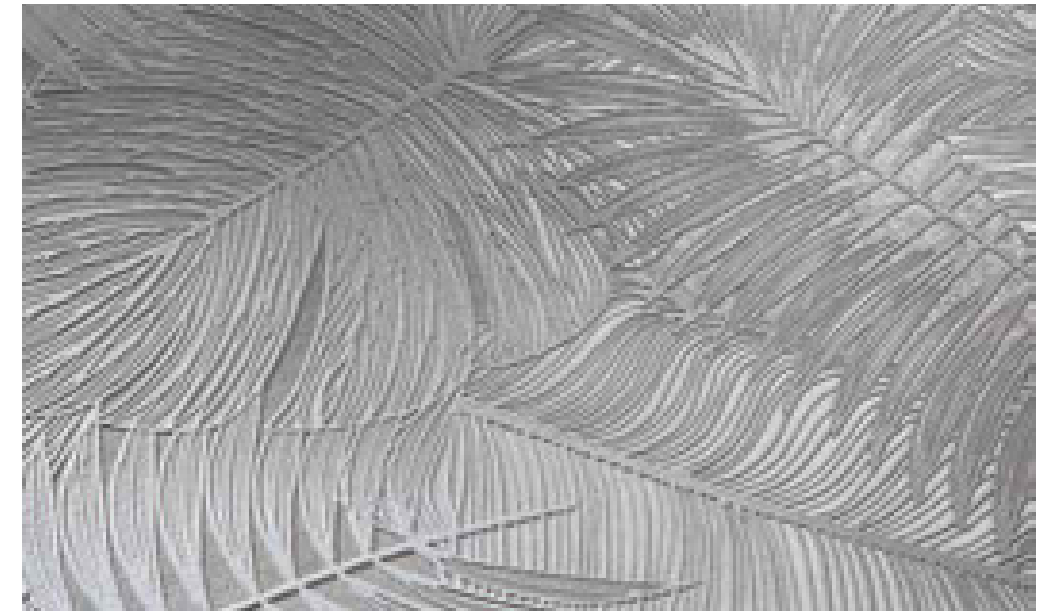

Myfair Grey Wall02



1070215
 60x120 . 24"x48" rett
 ● **B62C**



Spring Wall10

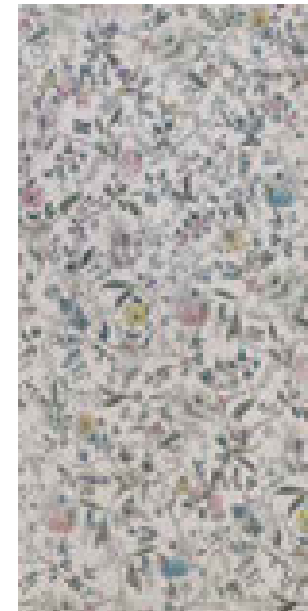

1069827
 60x120 . 24"x48" rett
 ● **B62C**



SHOWALL

Decorì da rivestimento ad uso residenziale interno.
 Wall decorations for interior residential.
 D cor mural pour usage r sidentiel int rieur.
 Wanddekore nur f r Innenbereich geeignet.

Gres fine porcellanato smaltato
 Glazed fine porcelain stoneware
 Gr s c r me fin  maill e
 Glasiertes Feinsteinzeug



9,5 MM
3/8"

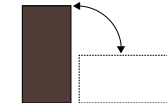

BOX		
PZ	SQM	KGS
2	1,44	31,00

Fabulous Pink Wall11



1069829
 60x120 . 24"x48" rett
 ● B62C

Foliage Gold Wall23



1081879
 60x120 . 24"x48" rett
 ● B63B

Fabulous Blue Wall12



1069831
 60x120 . 24"x48" rett
 ● B62C

Foliage Silver Wall24



1081880
 60x120 . 24"x48" rett
 ● B63B

SHOWALL

Decorì da rivestimento ad uso residenziale interno.
 Wall decorations for interior residential.
 D cor mural pour usage r sidentiel int rieur.
 Wanddekore nur f r Innenbereich geeignet.

Gres fine porcellanato smaltato
 Glazed fine porcelain stoneware
 Gr s c r me fin  maill e
 Glasiertes Feinsteinzeug



PICS AND STORIES
 FROM THIS COLLECTION

SMART
 GALLERY



9,5 MM
 3/8"

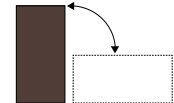

BOX		
PZ	SQM	KGS
2	1,44	31,00

Pixel Leaf Wall29



1082059
 60x120 . 24"x48" rett
 ● B63B

Flora Aqua Wall34



1082683
 60x120 . 24"x48" rett
 ● B63B

Flora Avorio Wall33



1082682
 60x120 . 24"x48" rett
 ● B63B





TADELAKT



Summak 60x120 rett / 120x120 rett
Berberè 60x120 rett



TADELAKT

Colours

JASMINE



KAMUN



SUMMAK



Gres fine porcellanato smaltato

Glazed fine porcelain stoneware . Grès cérame fin émaillé . Glasiertes Feinsteinzeug

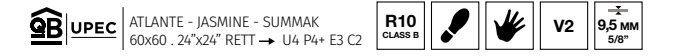

ATLANTE



BERBERÈ



MEDINA



TADELAKT

Colours

NANÀ



Gres fine porcellanato smaltato
Glazed fine porcelain stoneware . Grès cérame fin émaillé . Glasiertes Feinsteinzeug

UPEC | ATLANTE - JASMINE - SUMMAK
60x60 - 24"x24" RETT → U4 P4+ E3 C2



Nanà 60x120 rett
Mosaico Nanà S/2 30x30 rett

TADELAKT

Colours

INSERTO MAJORELLE MIX JASMINE



INSERTO MAJORELLE MIX KAMUN



INSERTO MAJORELLE MIX SUMMAK







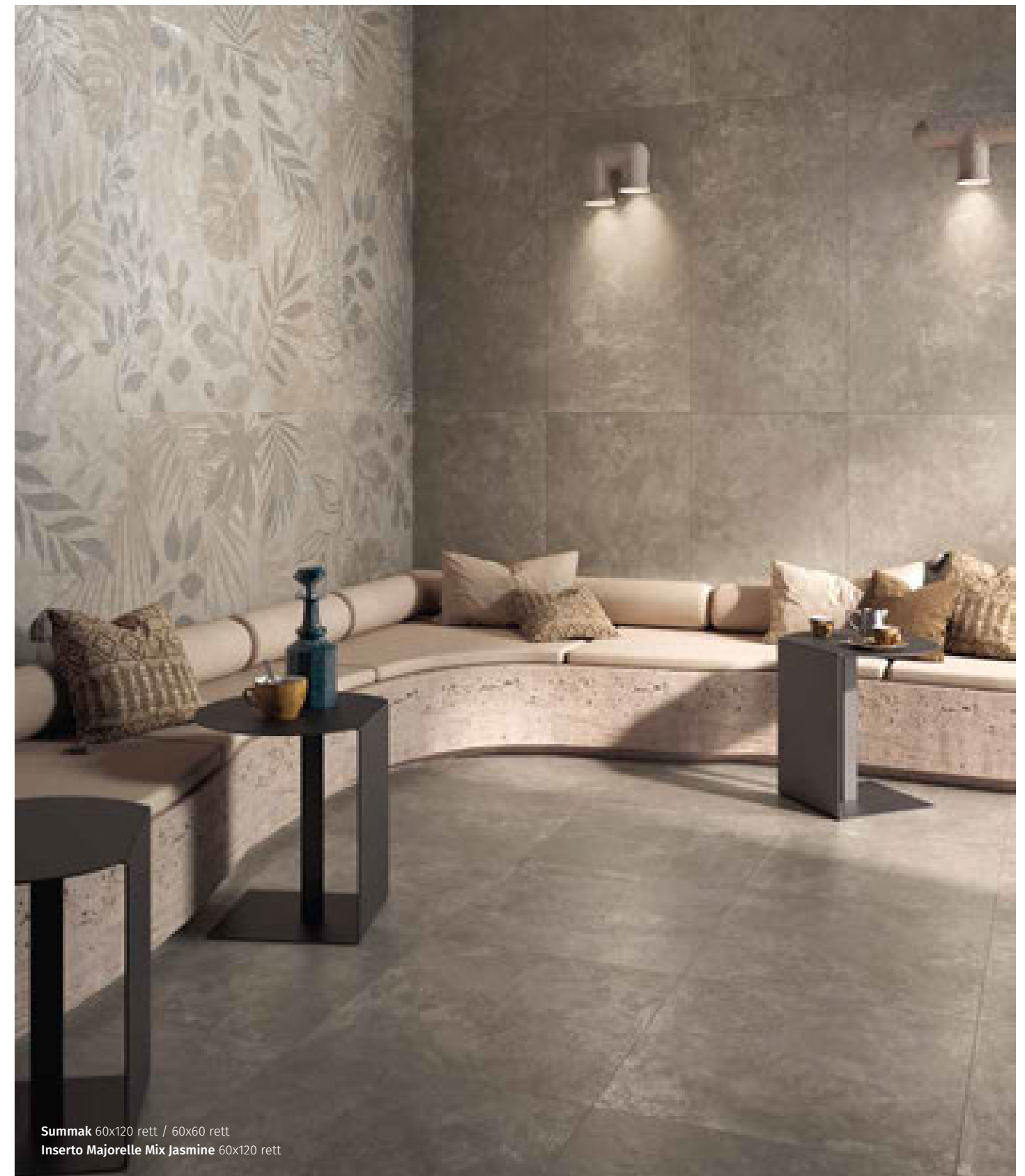
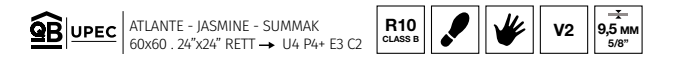



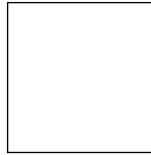
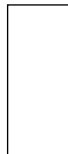

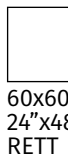
Gres fine porcellanato smaltato

Glazed fine porcelain stoneware . Grès cérame fin émaillé . Glasiertes Feinsteinzeug



Summak 60x120 rett / 60x60 rett
Inserto Majorelle Mix Jasmine 60x120 rett

FORMATO NOMINALE Nominal Size Format Nominal Nennformat	ARTICOLO Item Article Artikel	FASCE DI PREZZO Price ranges Groupes des prix Preisgruppen	BOX			PALLET		
			PEZZI Pieces Pièces Stücke	MQ Sqm Mc Qm	KG	SCATOLE Boxes Boîtes Kartons	MQ Sqm Mc Qm	KG
 120x120 cm 48"x48" RETT	1081761 Jasmine 1081762 Kamun 1081763 Summak	A38	1	1,44	31,00	40	57,60	1.300
 60x120 cm 24"x48" RETT	1081764 Atlante 1081765 Berberè 1081766 Jasmine 1081767 Kamun 1081768 Medina 1081769 Nanà 1081770 Summak	A28	2	1,44	31,00	36	51,84	1.144
 INSERTO MAJORELLE MIX 60x120 cm 24"x48" RETT	1081778 Inserto Majorelle Mix Jasmine 1081779 Inserto Majorelle Mix Kamun 1081780 Inserto Majorelle Mix Summak	A36B	2	1,44	31,00	36	51,84	1.144
 60x60 cm 24"x48" RETT	1081771 Atlante 1081772 Berberè 1081773 Jasmine 1081774 Kamun 1081775 Medina 1081776 Nanà 1081777 Summak	A13	3	1,08	22,80	40	43,20	928
 MOSAICO BERBERÈ 23,4x23,4 cm 9 1/4"x9 1/4" RETT	1082256 Mosaico Berberè	B21	5					
 MOSAICO MEDINA 30x30 cm 12"x12" RETT	1082260 Mosaico Medina	B18	5					
 MOSAICO NANÀ 30x30 cm 12"x12" RETT	1082261 Mosaico Nanà S/2	B22	6					

FORMATO NOMINALE Nominal Size Format Nominal Nennformat	ARTICOLO Item Article Artikel	FASCE DI PREZZO Price ranges Groupes des prix Preisgruppen	BOX			PALLET		
			PEZZI Pieces Pièces Stücke	MQ Sqm Mc Qm	KG	SCATOLE Boxes Boîtes Kartons	MQ Sqm Mc Qm	KG
 MOSAICO CASABLANCA */** 25x25 cm 10"x10" RETT	1082257 Mosaico Casablanca Blu 1082291 Mosaico Casablanca Verde	B14	5					
 MOSAICO FEZ */** 30x30 cm 12"x12" RETT	1082258 Mosaico Tessera Mix Fez Blu 1082293 Mosaico Tessera Mix Fez Verde 1082292 Mosaico Tessera Mix Fez Blu/Verde	B18	5					
 MOSAICO MARRAKECH */** 30x30 cm 12"x12" RETT	1082259 Mosaico Marrakech Mix Blu 1082295 Mosaico Marrakech Mix Verde 1082294 Mosaico Marrakech Mix Blu/Verde	B16	5					
 BATTISCOPIA 6,5x60 cm 29/16"x24" RETT	1082245 Atlante 1082246 Berberè 1082247 Jasmine 1082248 Kamun 1082249 Medina 1082250 Nanà 1082251 Summak	C5	12	ml 7,20	11,00			

* **Decorì da rivestimento ad uso residenziale interno.**
Wall decorations for interior residential.
Décor mural pour usage résidentiel intérieur.
Wanddekore nur für Innenbereich geeignet.



VENEZIA



Bianco 20x20
Gesso 20x20
Nero 20x20



VENEZIA

Colours

BIANCO



GESSO



GRIGIO

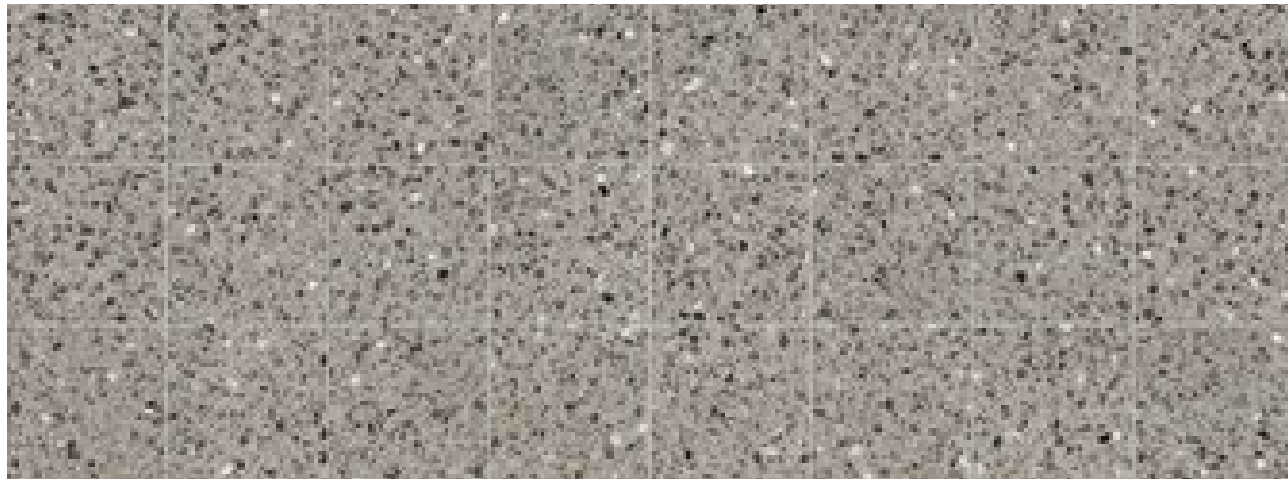

Gres fine porcellanato smaltato

Glazed fine porcelain stoneware . Grès cérame fin émaillé . Glasiertes Feinsteinzeug



NERO

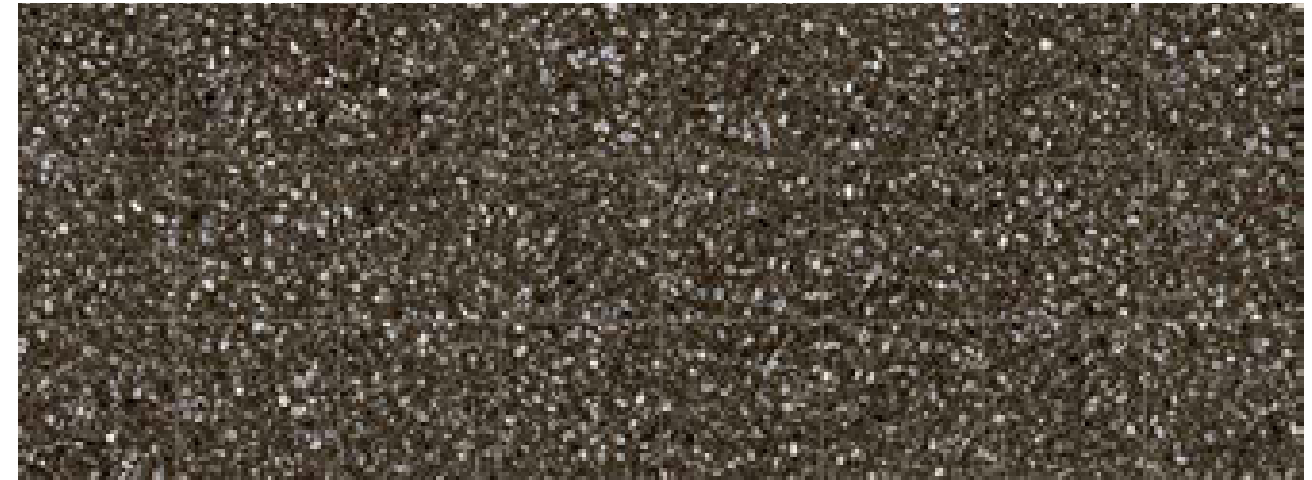

BLU

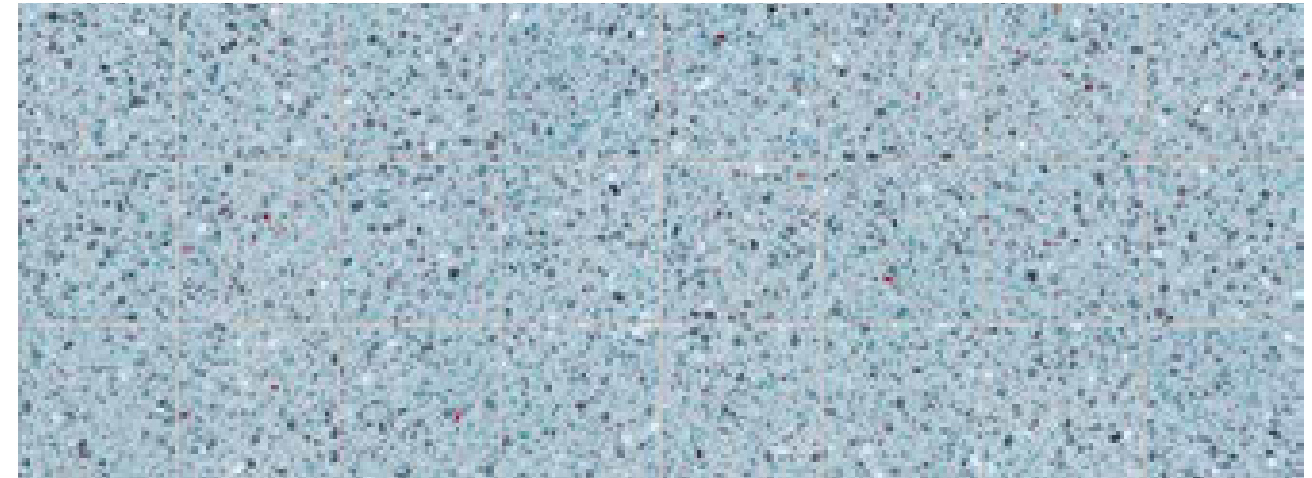

VENEZIA

Colours

SAN MARCO MIX *



CÀ FOSCARI BLU

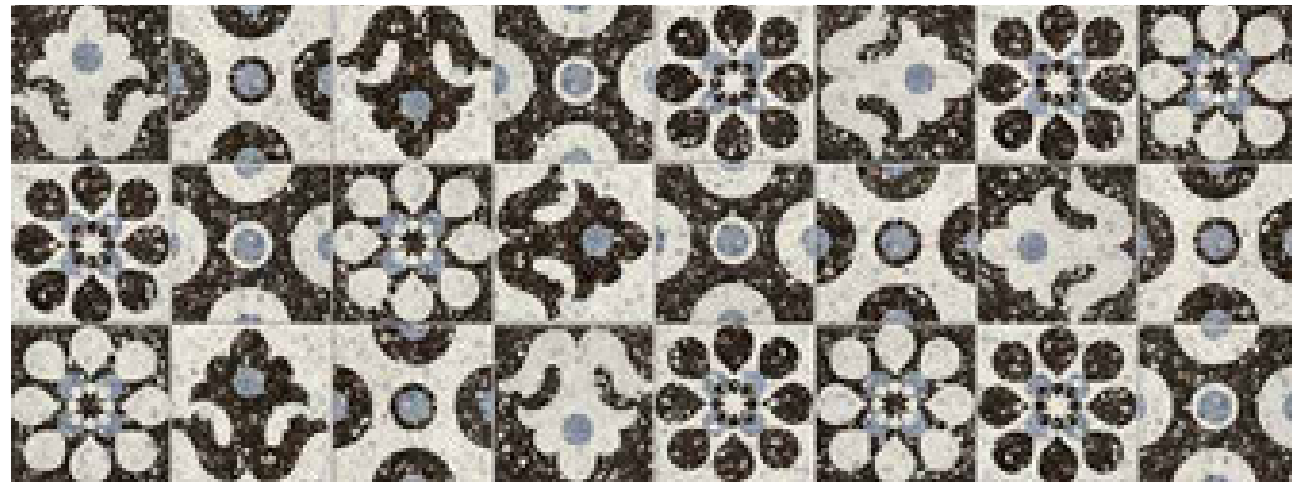

CÀ FOSCARI GRIGIO

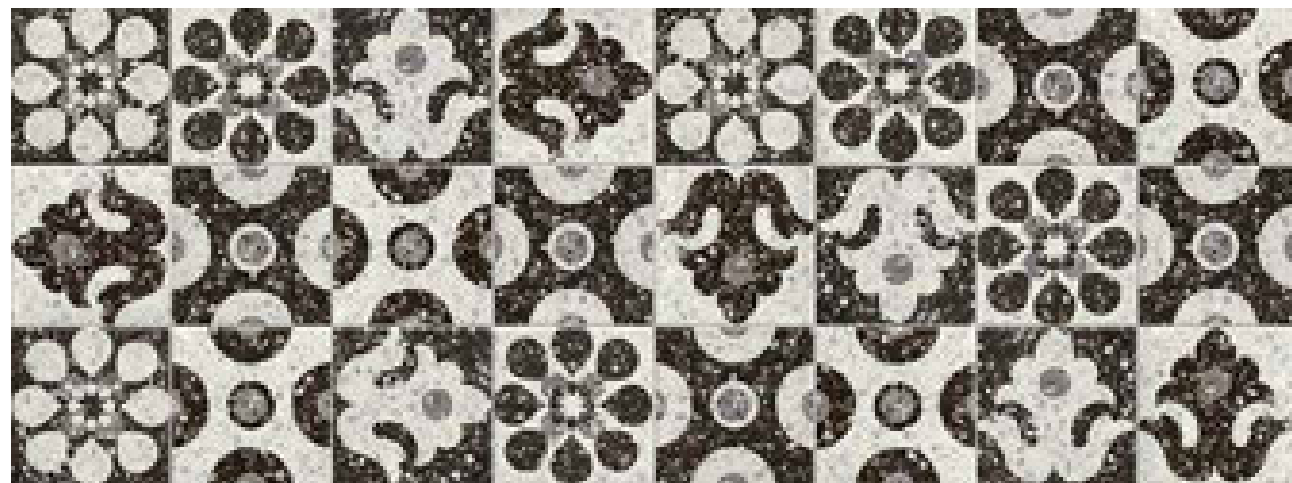

Gres fine porcellanato smaltato

Glazed fine porcelain stoneware . Grès cérame fin émaillé . Glasiertes Feinsteinzeug



RIALTO BLU



LA FENICE BLU



* 32 soggetti miscelati casualmente nelle scatole.

32 designs available with each box containing a random mix.

32 motifs mélangés au hasard dans les boîtes.

Die 32 Muster in den Schachteln werden nach dem Zufallsprinzip gemischt.



VENEZIA

FORMATO NOMINALE Nominal Size Format Nominal Nennformat	ARTICOLO Item Article Artikel	FASCE DI PREZZO Price ranges Groupes des prix Preisgruppen	BOX			PALLET		
			PEZZI Pieces Pièces Stücke	MQ Sqm Mc Qm	KG	SCATOLE Boxes Boîtes Kartons	MQ Sqm Mc Qm	KG
 20x20 cm 8"x8"	1059935 Venezia Bianco 1059936 Venezia Blu 1059937 Venezia Gesso 1059938 Venezia Grigio 1059939 Venezia Nero	A10	26	1,04	21,00	54	56,16	1.150
 SAN MARCO MIX * 20x20 cm 8"x8"	1059949 San Marco Mix	A19	26	1,04	21,00	54	56,16	1.150
 CA' FOSCARI 20x20 cm 8"x8"	1059947 Ca' Foscari Blu Mix 1059948 Ca' Foscari Grigio Mix	A19	26	1,04	21,00	54	56,16	1.150
 RIALTO 20x20 cm 8"x8"	1060045 Rialto Blu	A19	26	1,04	21,00	54	56,16	1.150
 LA FENICE 20x20 cm 8"x8"	1059943 La Fenice Blu	A19	26	1,04	21,00	54	56,16	1.150
 60x60 cm 24"x24" RETT	1060080 Venezia Bianco 1060082 Venezia Gesso 1060084 Venezia Nero	A13	3	1,08	24,50	32	34,56	800
 60x60 cm 24"x24" LUX-RETT	1060072 Venezia Bianco 1060076 Venezia Nero	A35	3	1,08	24,50	32	34,56	800
 GRICCIA ** 20x20 cm 8"x8"	1060981 Griccia Lampone 1060983 Griccia Turchese	B14	4					
 PAVONA ** 20x20 cm 8"x8"	1060985 Pavona Lampone 1060987 Pavona Turchese	B14	4					
 BACCHETTA 2x20 cm 13/16"x8"	1061107 Bacchetta Blu 1061108 Bacchetta Grigia	B8	6					

Gres fine porcellanato smaltato

Glazed fine porcelain stoneware . Grès cérame fin émaillé . Glasiertes Feinsteinzeug



FORMATO NOMINALE Nominal Size Format Nominal Nennformat	ARTICOLO Item Article Artikel	FASCE DI PREZZO Price ranges Groupes des prix Preisgruppen	BOX			PALLET		
			PEZZI Pieces Pièces Stücke	MQ Sqm Mc Qm	KG	SCATOLE Boxes Boîtes Kartons	MQ Sqm Mc Qm	KG
 BATTISCOPIA 6,5x60 cm 2 3/16"x24" RETT	1060961 Bianco 1060963 Gesso 1060965 Nero	C5	12	ml 7,20	11,00			
 BATTISCOPIA 6,5x60 cm 2 3/16"x24" LUX-RETT	1060969 Bianco 1060973 Nero	C6	12	ml 7,20	11,00			



Venezia Bianco 60x60 rett

Venezia Nero 60x60 rett

* 32 soggetti miscelati casualmente nelle scatole.

32 designs available with each box containing a random mix.
32 motifs mélangés au hasard dans les boîtes.

Die 32 Muster in den Schachteln werden nach den Zufallsprinzip gemischt.

**Decori da rivestimento ad uso residenziale interno.

Wall decorations for interior residential.
Décor mural pour usage résidentiel intérieur.

Wanddekore nur für Innenbereich geeignet.

SCHEMI DI POSA

Laying sketch . Schémas de pose . Modulverlegungsbeispiele

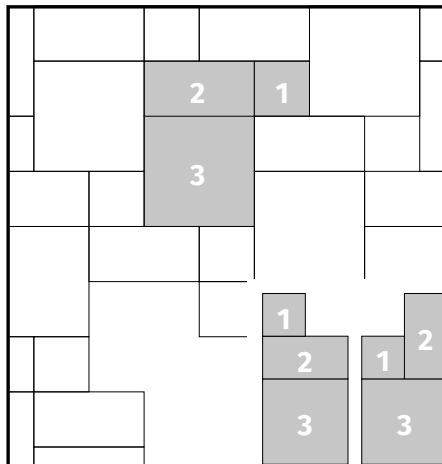

MODULARE 10
 1 - 20x20 = 14,30%
 2 - 20x40 = 28,60%
 3 - 40x40 = 57,10%

**CHICAGO
 COTTO DEL CAMPIANO
 DI PIETRA
 IN FALDA
 ITALICA
 HAVANA
 HERITAGE
 MOLO AUDACE
 REGGIO NELL'EMILIA**

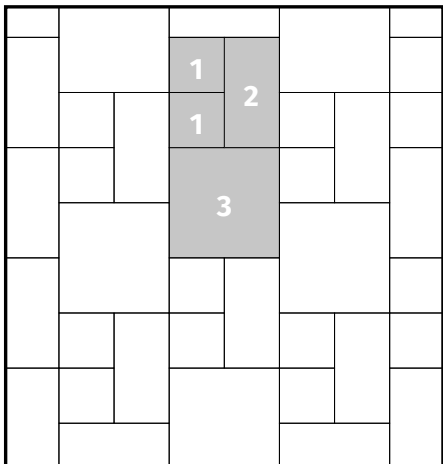

MODULARE 17
 1 - 20x20 = 25%
 2 - 20x40 = 25%
 3 - 40x40 = 50%

**CHICAGO
 COTTO DEL CAMPIANO
 DI PIETRA
 IN FALDA
 ITALICA
 HAVANA
 HERITAGE
 MOLO AUDACE
 REGGIO NELL'EMILIA**

La posa modulare è consigliata con una fuga di 4/5 mm.
 We recommend modular laying with a 4/5 mm ³/₁₆" joint.
 La pose modulaire est conseillée avec un joint de 4/5 mm.
 Die Modulverlegung wird mit einer Mindestfuge von 4/5 mm empfohlen.

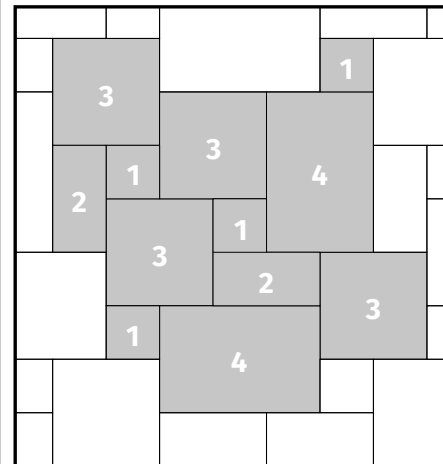

MODULARE 39
 1 - 20x20 = 11,10%
 2 - 20x40 = 11,10%
 3 - 40x40 = 44,40%
 4 - 40x60,8 = 33,40%

**COTTO DEL CAMPIANO
 DI PIETRA
 HERITAGE
 IN FALDA
 ITALICA
 MOLO AUDACE
 REGGIO NELL'EMILIA**

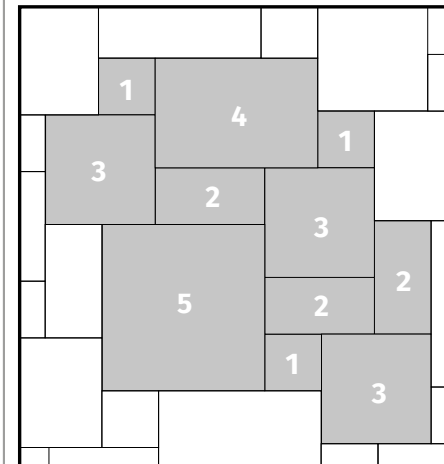

MODULARE 41
 1 - 20x20 = 8,26%
 2 - 20x40 = 16,52%
 3 - 40x40 = 33,04%
 4 - 40x60,8 = 16,74%
 5 - 60x60,8 = 25,44%

**DI PIETRA
 IN FALDA**

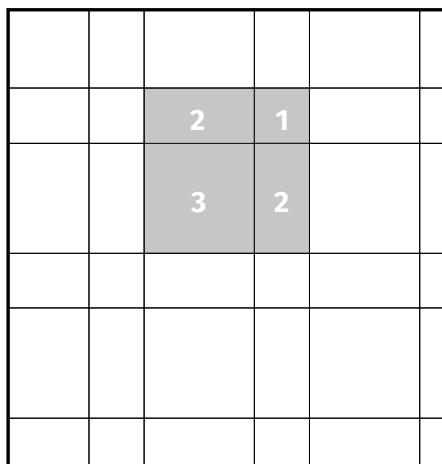

MODULARE 19
 1 - 20x20 = 11,10%
 2 - 20x40 = 44,45%
 3 - 40x40 = 44,45%

**CHICAGO
 COTTO DEL CAMPIANO
 DI PIETRA
 IN FALDA
 ITALICA
 HAVANA
 HERITAGE
 MOLO AUDACE
 REGGIO NELL'EMILIA**

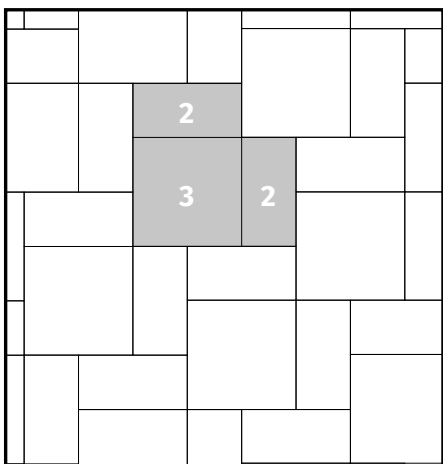

MODULARE 20
 1 - 20x40 = 50%
 2 - 40x40 = 50%

**CHICAGO
 COTTO DEL CAMPIANO
 DI PIETRA
 IN FALDA
 ITALICA
 HAVANA
 HERITAGE
 MOLO AUDACE
 REGGIO NELL'EMILIA**

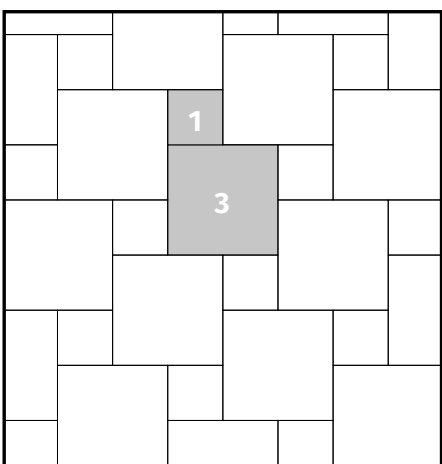

MODULARE 21
 1 - 20x20 = 20%
 2 - 40x40 = 80%

**CHICAGO
 COTTO DEL CAMPIANO
 DI PIETRA
 IN FALDA
 ITALICA
 HAVANA
 HERITAGE
 MOLO AUDACE
 REGGIO NELL'EMILIA**

SOLUZIONI TECNICHE PER L'ARCHITETTURA E IL DESIGN

Technical solutions for architecture and design . Solutions techniques pour l'architecture et le design . Technische Lösungen für Architektur und Design

UN SISTEMA DI SUPERFICI AFFIDABILE, VERSATILE E COMPLETO.

Il programma di superfici del Gruppo Romani è uno strumento completo per la progettazione degli spazi sia domestici che commerciali.

Le caratteristiche tecniche dei differenti spessori del gres porcellanato uniti a differenti metodi di posa, consentono di realizzare ambienti con esigenze complesse.

Tanti vantaggi pratici che si sommano alla ricchezza di gamma di pezzi speciali dedicati a piscine e pavimenti sopraelevati.

Ogni esigenza ha una risposta che risolve tecnicamente ed esteticamente le tematiche più complesse per elaborare spazi bellissimi, sicuri ed eterni.

UN SYSTÈME DE SURFACES FIABLE, POLYVALENT ET COMPLET.

Le programme de surfaces du Gruppo Romani est un outil complet pour la conception des espaces aussi bien résidentiels que tertiaires.

Les caractéristiques techniques des différentes épaisseurs du grès cérame, associées à différentes méthodes de pose, permettent la réalisation d'environnements aux exigences complexes.

Ces avantages pratiques s'ajoutent à la richesse de la gamme des pièces spéciales dédiées aux piscines et aux planchers surélevés. Chaque exigence a une réponse qui résout aussi bien sur le plan technique qu'esthétique les problèmes les plus complexes, afin de créer des espaces magnifiques, sûrs et éternels.

A RELIABLE, VERSATILE AND COMPLETE SURFACES SYSTEM.

The Gruppo Romani surfaces programme is a complete design tool for domestic and commercial spaces.

The technical features of porcelain stoneware in different thicknesses combined with different installation methods make it possible to create environments able to meet complex requirements.

A host of practical advantages, backed up by a vast range of trims for swimming pools and floating floors.

Each need has an answer that provides technical and aesthetic solutions in the most complex applications to create beautiful, safe and indestructible spaces.

EIN ZUVERLÄSSIGES, VIELSEITIGES UND KOMPLETTES OBERFLÄCHENSYSTEM.

Das Oberflächenprogramm von Gruppo Romani ist ein komplettes Instrument, mit dem man sowohl Wohn- als auch Geschäftsräume gestalten kann.

Die technischen Eigenschaften der verschiedenen Stärken von Feinsteinzeug ermöglichen zusammen mit den unterschiedlichen Verlegungsmethoden die Gestaltung von Räumen, deren komplexe Anforderungen vollauf erfüllt werden.

Viele praktische Vorteile, die eine breite Palette von Spezialstücken für Schwimmbäder und Doppelböden erweitern.

Für jeden Bedarf gibt es eine Lösung, die auch die komplexesten Probleme technisch und optisch löst, um wunderschöne, sichere und ewige Räume zu realisieren.



SOLUZIONI STRAORDINARIE IN OGNI CONDIZIONE. INDOOR & OUTDOOR

Exceptional solutions in all conditions. Indoor & outdoor . Solutions extraordinaires pour toutes les conditions. Indoor & outdoor
Aussergewöhnliche Lösungen unter allen Bedingungen. Indoor & outdoor



+ NON TEME GLI EVENTI ATMOSFERICI

*Completely weatherproof
Ne craint pas les intempéries
Witterungsfest*



NON ASSORBE ACQUA
*No water absorption
N'absorbe pas l'eau
Wasserfest*



RESISTE AL GELO
*Frost resistance
Résiste au gel
Frostbeständig*



RESISTE ALLO SHOCK TERMICO
*Thermal shock resistance
Résiste aux chocs thermiques
Thermoschockbeständig*



RESISTENZA TOTALE DEI COLORI ESPOSTI AL SOLE
*Total colour fastness on exposure to sunlight
Résistance totale des couleurs exposées au soleil
Lichtecht*

+ È SICURO

Safe / Sûr / Sicher



RESISTE ALLA SCIVOLOSITÀ
*Slip resistant
Résiste à la glissance
Rutschfest*



È IGNIFUGO
*Resistant to fire
Ignifuge
Feuerfest*

+ FORTE E RESISTENTE

*Tough and hard wearing
Solide et résistant
Stark und widerstandsfähig*

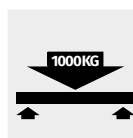

**RESISTE ALLA FLESSIONE E ALLA FORZA DI
ROTTURA**
2 cm / 1,5 cm

*Excellent modulus of rupture and breaking strength
Résiste à la flexion et à la force de rupture
Biege- und bruchfest*

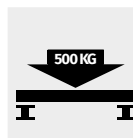

**RESISTE AI CARICHI DI ROTTURA CON
SUPPORTO PER PAVIMENTI SOPRAELEVATI**
2 cm

*Resists breaking loads with pedestals for raised floors
Résiste aux charges de rupture avec support pour
planchers surélevés
Bruchbeständig auf Stelzlager für Doppelböden*



È CARRABILE
2 cm / 1,5 cm

*Drive-over
Carrossable
Befahrbar*



RESISTE AL CALPESTIO
*Resistant to foot traffic
Résiste au piétinement
Widerstandsfähig gegen Fußgängerverkehr*

+ È PULITO

Clean / Propre / Sauber



RESISTE ALLE MACCHIE
*Stain resistant
Résiste aux taches
Fleckenbeständig*



È FACILE DA PULIRE
*Easy to clean
Facile d'entretien
Leicht zu reinigen*

+ NON TEME AGENTI ESTERNI

*Impervious to external agents
Ne craint pas les agents extérieurs
Resistent gegen äußere Einwirkungen*



RESISTE ALL'ATTACCO CHIMICO
*Resistance to chemical attack
Résiste aux attaques chimiques
Chemikalienbeständig*



RESISTE A MUFFE E MUSCHI
*Resistant to moulds and moss
Résiste aux moisissures
et aux mousses
Schimmel- und moosbeständig*



RESISTE AL SALE
*Resistant to salt
Résiste au sel
Salzbeständig*

+ UNA GAMMA COMPLETA PER ARREDARE

*A complete range for design projects
Une gamme complète pour décorer
Ein komplettes Ausstattungssortiment*



PRODOTTI COORDINABILI INDOOR/OUTDOOR
*Products that allow indoor/outdoor coordination
Produits assortis indoor/outdoor
Kombinierbare Indoor-/Outdoor-Produkte*



Vedi catalogo tecnico completo.

*See complete technical catalog
Voir le catalogue technique complet.
Siehe vollständigen technischen Katalog.*



NOTE TECNICHE PEZZI SPECIALI

Trims technical notes . Notes techniques concernant les pièces spéciales . Technische Hinweise zu den Formteile

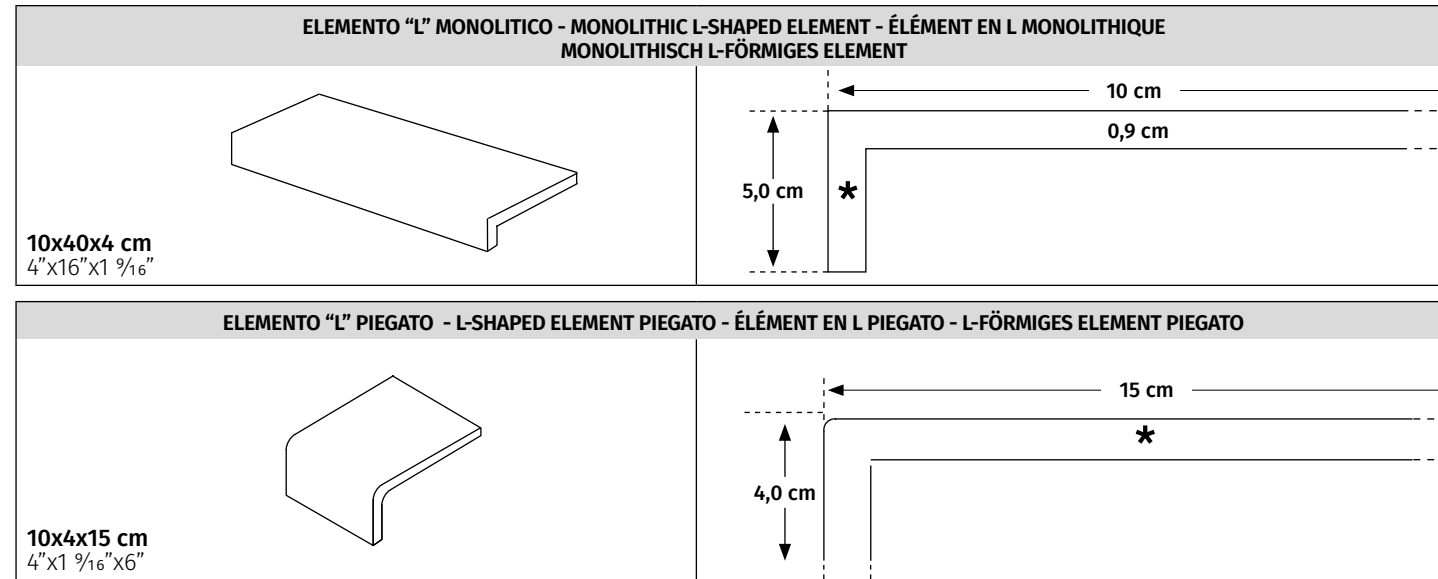

* Spessore piastrella
Tile Thickness
Epaisseur du carreau
Stärke der Fliese

Pezzi speciali e fondo possono differire in termini di tonalità, il bordo può presentare stratificazioni di tonalità diverse.
Special pieces and field tiles may come in different shades, the slab's edge may show layers of differing hues.
Il peut y avoir des différences de tonalités entre les pièces spéciales et le fond, le bord pourrait présenter des stratifications de tonalités différentes.
Die formteile können farblich von der grundplatte abweichen, ihre kanten können schichtungen in unterschiedlichen farbtönen AUFWEISEN.

NOTE TECNICHE SUI PEZZI SPECIALI 2 CM OUTDOOR

2 cm Technical notes trims . Remarques techniques sur le pièces spéciales 2 cm . Technische Hinweise zu den Formstücke 2 cm

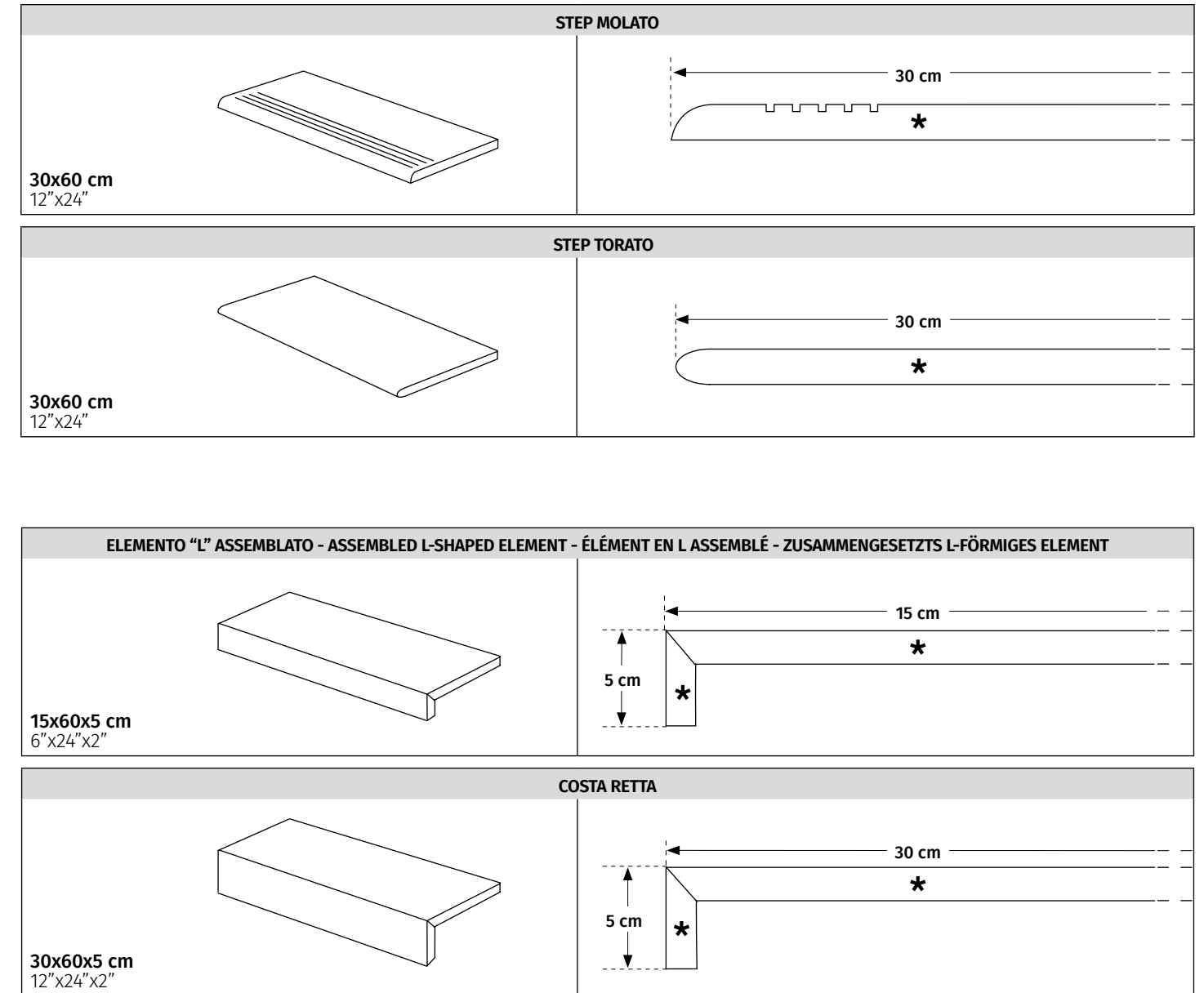

* Spessore piastrella
Tile Thickness
Epaisseur du carreau
Stärke der Fliese

Pezzi speciali e fondo possono differire in termini di tonalità, il bordo può presentare stratificazioni di tonalità diverse.
Special pieces and field tiles may come in different shades, the slab's edge may show layers of differing hues.
Il peut y avoir des différences de tonalités entre les pièces spéciales et le fond, le bord pourrait présenter des stratifications de tonalités différentes.
Die formteile können farblich von der grundplatte abweichen, ihre kanten können schichtungen in unterschiedlichen farbtönen AUFWEISEN.

	Proprietà fisico-chimiche Physical chemical properties / Propriétés physico chimiques Physisch chemische Eigenschaften	Metodo di prova / Standard of test / Norme du test / Testnorm	Boston Brick	Cotto del Campiano	Chicago	Chromagic	Di Pietra	Fuoritono	Havana
	Dimensioni / Dimensions Dimensions / Abmessungen								
	Aspetto superficiale Surface appearance / Aspect superficiel Oberflächenbeschaffenheit		≥ 95%	≥ 95%	≥ 95%	≥ 95%	≥ 95%	≥ 95%	≥ 95%
	Lunghezza e larghezza Length and width Longueur et largeur Länge und Breite	W 10 test	± 0,5% ± 2 mm	± 0,5% ± 2 mm	± 0,5% ± 2 mm	± 0,5% ± 1,5 mm	± 0,5% ± 2 mm	± 0,5% ± 2 mm	± 0,5% ± 2 mm
	Spessore Thickness / Epaisseur / Stärke	ISO 10545 - 2	± 5% ± 0,5 mm	± 5% ± 0,5 mm	± 5% ± 0,5 mm	± 5% ± 0,5 mm	± 5% ± 0,5 mm	± 5% ± 0,5 mm	± 5% ± 0,5 mm
	Rettilineità degli spigoli Straightness of sides / Rectitude des arrêtes / Kantengeradheit		± 0,3% ± 1,5 mm	± 0,3% ± 1,5 mm	± 0,5% ± 1,5 mm	± 0,5% ± 1,5 mm	± 0,5% ± 1,5 mm	± 0,5% ± 1,5 mm	± 0,5% ± 1,5 mm
	Ortogonalità Rectangularity / Orthogonalité / Rechtwinkligkeit		± 0,5% ± 2 mm	± 0,5% ± 2 mm	± 0,5% ± 2 mm	± 0,3% ± 1,5 mm	± 0,5% ± 2 mm	± 0,5% ± 2 mm	± 0,5% ± 2 mm
Planarità Surface flatness / Planéité / Ebenflächigkeit		± 0,5% ± 1,5 mm	± 0,5% ± 1,5 mm	± 0,5% ± 1,5 mm	± 0,3% ± 1,5 mm	± 0,5% ± 1,5 mm	± 0,5% ± 1,5 mm	± 0,5% ± 1,5 mm	
	Variazioni di tono Shade variations Variations de nuance Tonvariationen								
	Assorbimento d'acqua Water absorption Absorption d'eau Wasseraufnahme	ISO 10545 - 3	E ≤ 0,3% Bia GL	E ≤ 0,1% Bia GL	E ≤ 0,3% Bia GL	E ≤ 0,3% Bia GL	E ≤ 0,3% Bia GL	E ≤ 0,3% Bia GL	E ≤ 0,3% Bia GL
	Resistenza al gelo Frost resistance Résistance au gel Frostbeständigkeit	ISO 10545 - 12	Ingelivo Frost proof Ingelif Fröstsicher	Ingelivo Frost proof Ingelif Fröstsicher	Ingelivo Frost proof Ingelif Fröstsicher	Ingelivo Frost proof Ingelif Fröstsicher	Ingelivo Frost proof Ingelif Fröstsicher	Ingelivo Frost proof Ingelif Fröstsicher	Ingelivo Frost proof Ingelif Fröstsicher
	Coefficiente di dilatazione termica lineare (50°/400°) Linear thermal expansion coefficient (50°/400°) Dilatation thermique linéaire (50°/400°) Lineare Wärmeausdehnung (50°/400°)	ISO 10545 - 8	Metodo disponibile Test method available Méthode disponible Verfügbares Verfahren	Metodo disponibile Test method available Méthode disponible Verfügbares Verfahren	Metodo disponibile Test method available Méthode disponible Verfügbares Verfahren	Metodo disponibile Test method available Méthode disponible Verfügbares Verfahren	Metodo disponibile Test method available Méthode disponible Verfügbares Verfahren	Metodo disponibile Test method available Méthode disponible Verfügbares Verfahren	Metodo disponibile Test method available Méthode disponible Verfügbares Verfahren
	Resistenza agli sbalzi termici Resistance to thermal shock Résistance aux écarts de température Temperaturwechselbeständigkeit	ISO 10545 - 9	Resistente Resistant Résistant Widerstandsfähig	Resistente Resistant Résistant Widerstandsfähig	Resistente Resistant Résistant Widerstandsfähig	Resistente Resistant Résistant Widerstandsfähig	Resistente Resistant Résistant Widerstandsfähig	Resistente Resistant Résistant Widerstandsfähig	Resistente Resistant Résistant Widerstandsfähig
	Resistenza della superficie (scala MOHS) Scratch hardness (MOHS scale) Dureté de la surface (échelle MOHS) Oberflächenhärte (MOHS skala)	EN 101	MOHS ≥ 6	MOHS ≥ 6	MOHS ≥ 6	MOHS ≥ 6	MOHS ≥ 6	MOHS ≥ 6	MOHS ≥ 6
	Resistenza alla abrasione della superficie di piastrelle smaltate Resistance to surface abrasion of glazed tiles Résistance à l'abrasion de la surface des carreaux émaillés Widerstand gegen Abrieb der Oberfläche der glasierten Fliesen	ISO 10545 - 7	Classe / Class / Classe / Gruppe Reverse: 3 North End, Back Bay: 4 Southie: 5	Classe 4 Class 4 Classe 4 Gruppe 4	Classe 4 Class 4 Classe 4 Gruppe 4	Classe 4 Class 4 Classe 4 Gruppe 4	Classe / Class / Classe / Gruppe Creme Caramel, Elephant Skin, Ocean Surf, Sage and Butter, So Chic Brown: 3 Forever Pink, Green Guru, Perfect Nude: 4 Tasty Oyster: 5	Classe / Class / Classe / Gruppe Fuorimuschio, Fuorinero, Fuoripetrolio, Petrolio Opaco: 3 Ardenne Nero: 3 Ardenne Grigio, Runi Tortora, Bali Red: 4 Runi Avorio: 5	Classe 4 Class 4 Classe 4 Gruppe 4 Old Havana Mix Classe 3 Class 3 Classe 3 Gruppe 3
	Resistenza ai prodotti chimici di uso domestico Resistance to household chemicals Résistance aux produits chimiques ménagers Widerstand gegen Haushaltsreiner	ISO 10545 - 13	Classe A Class A Classe A Gruppe A	Classe A Class A Classe A Gruppe A	Classe A Class A Classe A Gruppe A	Classe A Class A Classe A Gruppe A	Classe A Class A Classe A Gruppe A	Classe A Class A Classe A Gruppe A	Classe A Class A Classe A Gruppe A
	Resistenza agli acidi e alle basi a bassa concentrazione Resistance to low concentrations of acids and bases Résistance aux acides et aux bases à faible concentration Widerstand gegen schwach konzentrierten Säuren und Laugen		Classe LA-HA Class LA-HA Classe LA-HA Gruppe LA-HA	Classe LA-HA Class LA-HA Classe LA-HA Gruppe LA-HA	Classe LA-HA Class LA-HA Classe LA-HA Gruppe LA-HA	Classe LA-HA Class LA-HA Classe LA-HA Gruppe LA-HA	Classe LA-HA Class LA-HA Classe LA-HA Gruppe LA-HA	Classe LA-HA Class LA-HA Classe LA-HA Gruppe LA-HA	Classe LA-HA Class LA-HA Classe LA-HA Gruppe LA-HA
	Resistenza alle macchie di piastrelle smaltate Resistance to stains of glazed tiles Résistance aux taches des carreaux émaillés Widerstand gegen Fleckenbildner der glasierten Fliesen	ISO 10545 - 14	Classe 5 Class 5 Classe 5 Gruppe 5	Classe 5 Class 5 Classe 5 Gruppe 5	Classe 5 Class 5 Classe 5 Gruppe 5	Classe 5 Class 5 Classe 5 Gruppe 5	Classe 5 Class 5 Classe 5 Gruppe 5	Classe 5 Class 5 Classe 5 Gruppe 5	Classe 5 Class 5 Classe 5 Gruppe 5
	Piombo e Cadmio rilasciati da piastrelle smaltate Lead and cadmium given off by glazed tiles Plomb et cadmium se dégagent des carreaux émaillés Von den glasierten Fliesen freigesetztes Blei und Kadmium	ISO 10545 - 15	Metodo disponibile Test method available Méthode disponible Verfügbares Verfahren	Metodo disponibile Test method available Méthode disponible Verfügbares Verfahren	-	-	Metodo disponibile Test method available Méthode disponible Verfügbares Verfahren	Metodo disponibile Test method available Méthode disponible Verfügbares Verfahren	-
	Resistenza alla flessione Bending strength Résistance à la flexion Biegezugfestigkeit	ISO 10545 - 4	Modulo di rottura / Modulus of rupture Module de rupture / Bruchmodul	Modulo di rottura / Modulus of rupture Module de rupture / Bruchmodul	Modulo di rottura / Modulus of rupture Module de rupture / Bruchmodul	Modulo di rottura / Modulus of rupture Module de rupture / Bruchmodul	Modulo di rottura / Modulus of rupture Module de rupture / Bruchmodul	Modulo di rottura / Modulus of rupture Module de rupture / Bruchmodul	Modulo di rottura / Modulus of rupture Module de rupture / Bruchmodul
	Carico di rottura / Breaking of rupture Charge de rupture / Bruchkraft		R ≥ 35 N/mm ² S ≥ 1300 N	R ≥ 35 N/mm ² S ≥ 1300 N	R ≥ 35 N/mm ² S ≥ 1300 N	R ≥ 35 N/mm ² S ≥ 1300 N	R ≥ 35 N/mm ² S ≥ 1300 N	R ≥ 35 N/mm ² S ≥ 1300 N	R ≥ 35 N/mm ² S ≥ 1300 N
	Caratteristiche antiscivolo / Coefficiente d'attrito statico Anti-slip properties / Static coefficient of friction Caractéristiques antidérapantes / Coefficient de frottement statique Rutschhemmende Eigenschaft / Statischer Reibungskoeffizient	DIN EN 16165 ANNEX B	R 10	R 10	R 10	R 10	R 10	R 10 (Sup. opaca)	R 10
		DIN EN 16165 ANNEX A	Classe A+B Class A+B Classe A+B Gruppe A+B	Classe A+B Class A+B Classe A+B Gruppe A+B	Classe A+B+C Class A+B+C Classe A+B+C Gruppe A+B+C	Classe A+B Class A+B Classe A+B Gruppe A+B	Classe A+B Class A+B Classe A+B Gruppe A+B	Classe A+B Class A+B Classe A+B Gruppe A+B	Classe A+B Class A+B Classe A+B Gruppe A+B
		B.C.R.A. REP. CEC. 6/81	0,40 ≤ M ≤ 0,74	0,40 ≤ M ≤ 0,74	0,40 ≤ M ≤ 0,74	R11: M ≥ 0,74	0,40 ≤ M ≤ 0,74	0,40 ≤ M ≤ 0,74	0,40 ≤ M ≤ 0,74
		ANSI A 326.3	M ≥ 0,42	M ≥ 0,42	M ≥ 0,42	M ≥ 0,42	M ≥ 0,42	M ≥ 0,42	M ≥ 0,42

	Proprietà fisico-chimiche Physical chemical properties / Propriétés physico chimiques Physisch chemische Eigenschaften	Metodo di prova / Standard of test / Norme du test / Testnorm	Heritage	In Falda	In Falda 2 cm outdoor	Italica	Materia Prima	Miami	Molo Audace	
	Dimensioni / Dimensions Dimensions / Abmessungen	ISO 10545 - 2								
	Aspetto superficiale Surface appearance / Aspect superficiel Oberflächenbeschaffenheit		≥ 95%	≥ 95%	≥ 95%	≥ 95%	≥ 95%	≥ 95%	≥ 95%	
	Lunghezza e larghezza Length and width Longueur et largeur Länge und Breite		± 0,5% ± 2 mm	± 0,5% ± 2 mm	± 0,5% ± 1,5 mm	± 0,5% ± 2 mm	± 0,5% ± 2 mm	± 0,5% ± 2 mm	± 0,5% ± 2 mm	
	Spessore Thickness / Epaisseur / Stärke		± 0,5% ± 2 mm	± 0,5% ± 2 mm	± 0,5% ± 1,5 mm	± 0,5% ± 2 mm	± 0,5% ± 2 mm	± 0,5% ± 2 mm	± 0,5% ± 2 mm	
	Rettilineità degli spigoli Straightness of sides / Rectitude des arrêtes / Kantengeradheit		± 5% ± 0,5 mm	± 5% ± 0,5 mm	± 5% ± 0,5 mm	± 5% ± 0,5 mm	± 5% ± 0,5 mm	± 5% ± 0,5 mm	± 5% ± 0,5 mm	
	Ortogonalità Rectangularity / Orthogonalité / Rechtwinkligkeit		± 0,5% ± 1,5 mm	± 0,5% ± 1,5 mm	± 0,5% ± 1,5 mm	± 0,5% ± 1,5 mm	± 0,5% ± 1,5 mm	± 0,5% ± 1,5 mm	± 0,5% ± 1,5 mm	
Planarità Surface flatness / Planéité / Ebenflächigkeit	± 0,5% ± 2 mm	± 0,5% ± 2 mm	± 0,3% ± 1,5 mm	± 0,5% ± 2 mm	± 0,5% ± 2 mm	± 0,5% ± 2 mm	± 0,5% ± 2 mm			
Planarità Surface flatness / Planéité / Ebenflächigkeit	± 0,5% ± 1,5 mm	± 0,5% ± 1,5 mm	± 0,3% ± 1,5 mm	± 0,5% ± 1,5 mm	± 0,5% ± 1,5 mm	± 0,5% < ± 1,5 mm	± 0,5% < ± 1,5 mm	± 0,5% < ± 1,5 mm		
	Variazioni di tono Shade variations Variations de nuance Tonvariationen		 FORTE STONALIZZAZIONE MODERATA VARIAZIONE EFFET RENFORCE TRÈS ACCENTUÉ STARK FARBEABWEICHUNG	 MODERATA VARIAZIONE MODERATE VARIATION VARIATION MODÉRÉE MÄSSIGE ABWEICHUNG	 MODERATA VARIAZIONE MODERATE VARIATION VARIATION MODÉRÉE MÄSSIGE ABWEICHUNG	 MODERATA VARIAZIONE MODERATE VARIATION VARIATION MODÉRÉE MÄSSIGE ABWEICHUNG	 LIEVE VARIAZIONE LIGHT VARIATION VARIATION MODÉRÉE GERINGE ABWEICHUNG	 MODERATA VARIAZIONE MODERATE VARIATION VARIATION MODÉRÉE MÄSSIGE ABWEICHUNG	 FORTE STONALIZZAZIONE MODERATA VARIAZIONE EFFET RENFORCE TRÈS ACCENTUÉ STARK FARBEABWEICHUNG	
	Assorbimento d'acqua Water absorption Absorption d'eau Wasseraufnahme	ISO 10545 - 3	E ≤ 0,3% Bia GL	E ≤ 0,3% Bia GL	E ≤ 0,3% Bia GL	E ≤ 0,3% Bia GL	E ≤ 0,3% Bia GL	E ≤ 0,3% Bia GL	E ≤ 0,3% Bia GL	
	Resistenza al gelo Frost resistance Résistance au gel Frostbeständigkeit	ISO 10545 - 12	Ingelivo Frost proof Ingelif Frostsicher	Ingelivo Frost proof Ingelif Frostsicher	Ingelivo Frost proof Ingelif Frostsicher	Ingelivo Frost proof Ingelif Frostsicher	Ingelivo Frost proof Ingelif Frostsicher	Ingelivo Frost proof Ingelif Frostsicher	Ingelivo Frost proof Ingelif Frostsicher	
	Coefficiente di dilatazione termica lineare (50°/400°) Linear thermal expansion coefficient (50°/400°) Dilatation thermique lineaire (50°/400°) Lineare Wärmeausdehnung (50°/400°)	ISO 10545 - 8	Metodo disponibile Test method available Méthode disponible Verfügbares Verfahren	Metodo disponibile Test method available Méthode disponible Verfügbares Verfahren	Metodo disponibile Test method available Méthode disponible Verfügbares Verfahren	Metodo disponibile Test method available Méthode disponible Verfügbares Verfahren	Metodo disponibile Test method available Méthode disponible Verfügbares Verfahren	Metodo disponibile Test method available Méthode disponible Verfügbares Verfahren	Metodo disponibile Test method available Méthode disponible Verfügbares Verfahren	
	Resistenza agli sbalzi termici Resistance to thermal shock Résistance aux écarts de température Temperaturwechselbeständigkeit	ISO 10545 - 9	Resistente Resistant Résistant Widerstandsfähig	Resistente Resistant Résistant Widerstandsfähig	Resistente Resistant Résistant Widerstandsfähig	Resistente Resistant Résistant Widerstandsfähig	Resistente Resistant Résistant Widerstandsfähig	Resistente Resistant Résistant Widerstandsfähig	Resistente Resistant Résistant Widerstandsfähig	
	Resistenza della superficie (scala MOHS) Scratch hardness (MOHS scale) Dureté de la surface (échelle MOHS) Oberflächenhärte (MOHS skala)	EN 101	MOHS ≥ 6	MOHS ≥ 6	MOHS ≥ 6	MOHS ≥ 6	MOHS ≥ 6	MOHS ≥ 6	MOHS ≥ 6	
	Resistenza alla abrasione della superficie di piastrelle smaltate Resistance to surface abrasion of glazed tiles Résistance à l'abrasion de la surface des carreaux émaillés Widerstand gegen Abrieb der Oberfläche der glasierten Fliesen	ISO 10545 - 7	Classe / Class / Classe / Gruppe Walnut: 4 Grey, Ivory: 5	Classe / Class / Classe / Gruppe Pietra di Rapolano: 4 Marmo Primavera, Perlato di Sicilia, Travertino Navona: 5	Classe / Class / Classe / Gruppe Marmo Primavera, Perlato di Sicilia, Travertino Navona: 5	Classe / Class / Classe / Gruppe Pearl, Sand, Rock: 3 Aqua, Ocean, Oyster, Seafom, Shell, Sky: 4 Wave: 5	Classe / Class / Classe / Gruppe Navy Sea: 2 Grey Velvet, Metropolitan Grey, Black Storm, Pink Velvet, Jewel, Soft Mint, Hunter Green, North Pole: 3 Cloud White: 4	Classe / Class / Classe / Gruppe Light Brown, Pitch Black, Green Blue, Red Clay: 3 Dust Grey, White Rope: 4	Classe / Class / Classe / Gruppe Nero Galera, Rosso d'Amante: 3 Bocca di Lupo, Torro d'Ormeccio: 4 Bitta di Porto, Grigio di Scotta: 5	
	Resistenza ai prodotti chimici di uso domestico Resistance to household chemicals Résistance aux produits chimiques ménagers Widerstand gegen Haushaltsreiner	ISO 10545 - 13	Classe A Class A Classe A Gruppe A	Classe A Class A Classe A Gruppe A	Classe A Class A Classe A Gruppe A	Classe A Class A Classe A Gruppe A	Classe A Class A Classe A Gruppe A	Classe A Class A Classe A Gruppe A	Classe A Class A Classe A Gruppe A	
	Resistenza agli acidi e alle basi a bassa concentrazione Resistance to low concentrations of acids and bases Résistance aux acides et aux bases à faible concentration Widerstand gegen schwach konzentrierten Säuren und Laugen		Classe LA-HA Class LA-HA Classe LA-HA Gruppe LA-HA	Classe LA-HA Class LA-HA Classe LA-HA Gruppe LA-HA	Classe LA-HA Class LA-HA Classe LA-HA Gruppe LA-HA	Classe LA-HA Class LA-HA Classe LA-HA Gruppe LA-HA	Classe LA Class LA Classe LA Gruppe LA	Classe LA Class LA Classe LA Gruppe LA	Classe LA Class LA Classe LA Gruppe LA	
	Resistenza alle macchie di piastrelle smaltate Resistance to stains of glazed tiles Résistance aux taches des carreaux émaillés Widerstand gegen Fleckenbildner der glasierten Fliesen	ISO 10545 - 14	Classe 5 Class 5 Classe 5 Gruppe 5	Classe 5 Class 5 Classe 5 Gruppe 5	Classe 5 Class 5 Classe 5 Gruppe 5	Classe 5 Class 5 Classe 5 Gruppe 5	Classe 5 Class 5 Classe 5 Gruppe 5	Classe 5 Class 5 Classe 5 Gruppe 5	Classe 5 Class 5 Classe 5 Gruppe 5	
	Piombo e Cadmio rilasciati da piastrelle smaltate Lead and cadmium given off by glazed tiles Plomb et cadmium se dégagent des carreaux émaillés Von den glasierten Fliesen freigesetztes Blei und Kadmium	ISO 10545 - 15	Metodo disponibile Test method available Méthode disponible Verfügbares Verfahren	Metodo disponibile Test method available Méthode disponible Verfügbares Verfahren	Metodo disponibile Test method available Méthode disponible Verfügbares Verfahren	Metodo disponibile Test method available Méthode disponible Verfügbares Verfahren	Metodo disponibile Test method available Méthode disponible Verfügbares Verfahren	Metodo disponibile Test method available Méthode disponible Verfügbares Verfahren	-	
	Resistenza alla flessione Bending strength Résistance à la flexion Biegezugfestigkeit	ISO 10545 - 4	Modulo di rottura / Modulus of rupture Module de rupture / Bruchmodul R ≥ 35 N/mm²	Modulo di rottura / Modulus of rupture Module de rupture / Bruchmodul R ≥ 35 N/mm²	Modulo di rottura / Modulus of rupture Module de rupture / Bruchmodul R ≥ 50 N/mm²	Modulo di rottura / Modulus of rupture Module de rupture / Bruchmodul R ≥ 35 N/mm²	Modulo di rottura / Modulus of rupture Module de rupture / Bruchmodul R ≥ 35 N/mm²	Modulo di rottura / Modulus of rupture Module de rupture / Bruchmodul R ≥ 35 N/mm²	Modulo di rottura / Modulus of rupture Module de rupture / Bruchmodul R ≥ 35 N/mm²	
	Carico di rottura / Breaking of rupture Charge de rupture / Bruchkraft S ≥ 1300 N		S ≥ 1300 N	S ≥ 1300 N	S ≥ 5000 N	S ≥ 1300 N	S ≥ 1300 N	S ≥ 1300 N	S ≥ 1300 N	
	Caratteristiche antiscivolo / Coefficiente d'attrito statico Anti-slip properties / Static coefficient of friction Caractéristiques antidérapantes / Coefficient de frottement statique Rutschhemmende Eigenschaft / Statischer Reibungskoeffizient	DIN EN 16165 ANNEX B	R 10	R 11	R 10	R 11	R 10	R 9	R 10	
		DIN EN 16165 ANNEX A	Classe A+B Class A+B Classe A+B Gruppe A+B	Classe A+B+C Class A+B+C Classe A+B+C Gruppe A+B+C	Classe A+B Class A+B Classe A+B Gruppe A+B	Classe A+B+C Class A+B+C Classe A+B+C Gruppe A+B+C	Classe A+B Class A+B Classe A+B Gruppe A+B	Classe A Class A Classe A Gruppe A	Classe A+B Class A+B Classe A+B Gruppe A+B	Classe A+B Class A+B Classe A+B Gruppe A+B
		B.C.R.A. REP. CEC. 6/81	0,40 ≤ M ≤ 0,74	0,40 ≤ M ≤ 0,74	M ≤ 0,74	M ≤ 0,74	0,40 ≤ M ≤ 0,74	-	0,40 ≤ M ≤ 0,74	0,40 ≤ M ≤ 0,74
	Le classement UPEC du carrelage	ANSI A 326.3	M ≥ 0,42	M ≥ 0,42	M ≥ 0,42	M ≥ 0,42	M ≥ 0,42	M ≥ 0,42	M ≥ 0,42	
				60,8x60,8 . 24"x24" → U4 P4+ E3 C2						

	Proprietà fisico-chimiche Physical chemical properties / Propriétés physico chimiques Physisch chemische Eigenschaften	Metodo di prova / Standard of test / Norme du test / Testnorm	New Orleans	New York	Reggio nell'Emilia	Showall	Tadelakt	Venezia
	Dimensioni / Dimensions Dimensions / Abmessungen							
	Aspetto superficiale Surface appearance / Aspect superficiel Oberflächenbeschaffenheit		≥ 95%	≥ 95%	≥ 95%	≥ 95%	≥ 95%	≥ 95%
	Lunghezza e larghezza Length and width Longueur et largeur Länge und Breite	W 10 test	± 0,5% ± 2 mm	± 0,5% ± 2 mm	± 0,5% ± 2 mm	± 0,5% ± 1,5 mm	± 0,5% ± 1,5 mm	± 0,5% ± 2 mm
	Spessore Thickness / Epaisseur / Stärke	ISO 10545 - 2	± 0,5% ± 2 mm	± 0,5% ± 2 mm	± 0,5% ± 2 mm	± 0,5% ± 1,5 mm	± 0,5% ± 1,5 mm	± 0,5% ± 2 mm
	Spessore Thickness / Epaisseur / Stärke		± 5% ± 0,5 mm	± 5% ± 0,5 mm	± 5% ± 1,5 mm	± 5% ± 0,5 mm	± 5% ± 0,5 mm	± 5% ± 0,5 mm
	Rettilinearità degli spigoli Straightness of sides / Rectitude des arrêtes / Kantengeradheit		± 0,5% ± 1,5 mm	± 0,5% ± 1,5 mm	± 0,5% ± 1,5 mm	± 0,5% ± 1,5 mm	± 0,5% ± 1,5 mm	± 0,5% ± 1,5 mm
	Ortogonalità Rectangularity / Orthogonalité / Rechtwinkligkeit		± 0,5% ± 2 mm	± 0,5% ± 2 mm	± 0,5% ± 2 mm	± 0,3% ± 1,5 mm	± 0,3% ± 1,5 mm	± 0,3% ± 2 mm
Planarità Surface flatness / Planéité / Ebenflächigkeit		± 0,5% ± 1,5 mm	± 0,5% ± 1,5 mm	± 0,5% ± 0,5 mm	± 0,3% ± 1,5 mm	± 0,3% ± 1,5 mm	± 0,3% ± 1,5 mm	
	Variazioni di tono Shade variations Variations de nuance Tonvariationen		 FORTE STONALIZZAZIONE SUBSTANTIAL VARIATION EFFET DÉMARQUÉ TRÈS ACCENTUÉ STARKE FARBABWEICHUNG	 FORTE STONALIZZAZIONE SUBSTANTIAL VARIATION EFFET DÉMARQUÉ TRÈS ACCENTUÉ STARKE FARBABWEICHUNG	 FORTE STONALIZZAZIONE SUBSTANTIAL VARIATION EFFET DÉMARQUÉ TRÈS ACCENTUÉ STARKE FARBABWEICHUNG	-	 LIEVE VARIAZIONE LIGHT VARIATION LEGÈRE VARIATION GERINGE ABWEICHUNG	 MODERATA VARIAZIONE MODERATE VARIATION MODÉRÉE VARIATION MASSIGE ABWEICHUNG
	Assorbimento d'acqua Water absorption Absorption d'eau Wasseraufnahme	ISO 10545 - 3	E ≤ 0,3% Bla GL	E ≤ 0,3% Bla GL	E ≤ 0,3% Bla GL	E ≤ 0,3% Bla GL	E ≤ 0,1%	E ≤ 0,3% Bla GL
	Resistenza al gelo Frost resistance Résistance au gel Frostbeständigkeit	ISO 10545 - 12	Ingelivo Frost proof Ingelif Fröstsicher	Ingelivo Frost proof Ingelif Fröstsicher	Ingelivo Frost proof Ingelif Fröstsicher	Ingelivo Frost proof Ingelif Fröstsicher	Ingelivo Frost proof Ingelif Fröstsicher	Ingelivo Frost proof Ingelif Fröstsicher
	Coefficiente di dilatazione termica lineare (50°/400°) Linear thermal expansion coefficient (50°/400°) Dilatation thermique linéaire (50°/400°) Lineare Wärmeausdehnung (50°/400°)	ISO 10545 - 8	Metodo disponibile Test method available Méthode disponible Verfügbares Verfahren	Metodo disponibile Test method available Méthode disponible Verfügbares Verfahren	Metodo disponibile Test method available Méthode disponible Verfügbares Verfahren	Metodo disponibile Test method available Méthode disponible Verfügbares Verfahren	Metodo disponibile Test method available Méthode disponible Verfügbares Verfahren	Metodo disponibile Test method available Méthode disponible Verfügbares Verfahren
	Resistenza agli sbalzi termici Resistance to thermal shock Résistance aux écarts de température Temperaturwechselbeständigkeit	ISO 10545 - 9	Resistente Resistant Résistant Widerstandsfähig	Resistente Resistant Résistant Widerstandsfähig	Resistente Resistant Résistant Widerstandsfähig	Resistente Resistant Résistant Widerstandsfähig	Resistente Resistant Résistant Widerstandsfähig	Resistente Resistant Résistant Widerstandsfähig
	Resistenza della superficie (scala MOHS) Scratch hardness (MOHS scale) Dureté de la surface (échelle MOHS) Oberflächenhärte (MOHS skala)	EN 101	MOHS ≥ 6	MOHS ≥ 6	MOHS ≥ 6	MOHS ≥ 6	MOHS ≥ 6	MOHS ≥ 6
	Resistenza alla abrasione della superficie di piastrelle smaltate Resistance to surface abrasion of glazed tiles Résistance à l'abrasion de la surface des carreaux émaillés Widerstand gegen Abrieb der Oberfläche der glasierten Fliesen	ISO 10545 - 7	Classe 4 Class 4 Classe 4 Gruppe 4	Classe 4 Class 4 Classe 4 Gruppe 4	Classe / Class / Classe / Gruppe Pieve: 3 Due Maestà, Rosta Nuova: 4 Broletto: 5	-	Classe 3-4 Class 3-4 Classe 3-4 Gruppe 3-4	Classe / Class / Classe / Gruppe Venezia Nero: 3 Venezia Bianco, Venezia Blu, Venezia Gesso, Venezia Grigio: 4
	Resistenza ai prodotti chimici di uso domestico Resistance to household chemicals Résistance aux produits chimiques ménagers Widerstand gegen Haushaltsreiner	ISO 10545 - 13	Classe A Class A Classe A Gruppe A	Classe A Class A Classe A Gruppe A	Classe A Class A Classe A Gruppe A	-	Classe A Class A Classe A Gruppe A	Classe A Class A Classe A Gruppe A
	Resistenza agli acidi e alle basi a bassa concentrazione Resistance to low concentrations of acids and bases Résistance aux acides et aux bases à faible concentration Widerstand gegen schwach konzentrierten Säuren und Laugen		Classe LA-HA Class LA-HA Classe LA-HA Gruppe LA-HA	Classe LA-HA Class LA-HA Classe LA-HA Gruppe LA-HA	Classe LA-HA Class LA-HA Classe LA-HA Gruppe LA-HA	-	Classe LA Class LA Classe LA Gruppe LA	Classe LA-HA Class LA-HA Classe LA-HA Gruppe LA-HA
	Resistenza alle macchie di piastrelle smaltate Resistance to stains of glazed tiles Résistance aux taches des carreaux émaillés Widerstand gegen Fleckenbildner der glasierten Fliesen	ISO 10545 - 14	Classe 5 Class 5 Classe 5 Gruppe 5	Classe 5 Class 5 Classe 5 Gruppe 5	Classe 5 Class 5 Classe 5 Gruppe 5	-	Classe 5 Class 5 Classe 5 Gruppe 5	Classe 5 Class 5 Classe 5 Gruppe 5
	Piombo e Cadmio rilasciati da piastrelle smaltate Lead and cadmium given off by glazed tiles Plomb et cadmium se dégageant des carreaux émaillés Von den glasierten Fliesen freigesetztes Blei und Kadmium	ISO 10545 - 15	Metodo disponibile Test method available Méthode disponible Verfügbares Verfahren	-	-	-	-	-
	Resistenza alla flessione Bending strength Résistance à la flexion Biegezugfestigkeit	ISO 10545 - 4	Modulo di rottura / Modulus of rupture Module de rupture / Bruchmodul	R ≥ 35 N/mm ²	R ≥ 35 N/mm ²	R ≥ 35 N/mm ²	-	R ≥ 35 N/mm ²
	Carico di rottura / Breaking of rupture Charge de rupture / Bruchkraft		S ≥ 1300 N	S ≥ 1300 N	S ≥ 1300 N	-	S ≥ 1300 N	S ≥ 1300 N
	Caratteristiche antiscivolo / Coefficiente d'attrito statico Anti-slip properties / Static coefficient of friction Caracteristiques antidérapantes / Coefficient de frottement statique Rutschhemmende Eigenschaft / Statischer Reibungskoeffizient	DIN EN 16165 ANNEX B	R 10	R 10	R 10	R 11	-	R 10
		DIN EN 16165 ANNEX A	Classe A+B Class A+B Classe A+B Gruppe A+B	Classe A+B Class A+B Classe A+B Gruppe A+B	Classe A Class A Classe A Gruppe A	Classe A+B+C Class A+B+C Classe A+B+C Gruppe A+B+C	-	Classe A+B Class A+B Classe A+B Gruppe A+B
		B.C.R.A. REP. CEC. 6/81	0,40 ≤ M ≤ 0,74	0,40 ≤ M ≤ 0,74	0,40 ≤ M ≤ 0,74	-	0,40 ≤ M ≤ 0,74	0,40 ≤ M ≤ 0,74
		ANSI A 326.3	M ≥ 0,42	M ≥ 0,42	M ≥ 0,42	-	M ≥ 0,42	M ≥ 0,42
	Le classement UPEC du carrelage	-	-	-	-	-	ATLANTE - JASMINE - SUMMAK 60x60 - 24"x24" RETT → U4 P4+ E3 C2	-

CARATTERISTICHE TECNICHE

Technical Features . Caracteristiques Techniques . Technische Eigenschaften

SCIVOLOSITÀ

La resistenza allo scivolamento è una caratteristica che ricade su sicurezza e salute degli utilizzatori, ovviamente nel caso di pavimentazioni. Le superfici scivolose sono potenziali cause di infortuni, anche gravi sia in ambito civile che negli ambienti di lavoro. La grandezza che quantifica la resistenza allo scivolamento è il coefficiente di attrito (statico o dinamico), al quale è proporzionale la forza, parallela alla superficie di contatto, che occorre applicare perchè si abbia moto relativo tra due corpi, e quindi anche la forza che ne definisce le condizioni di equilibrio. Quanto più alto è il coefficiente di attrito, tanto minore è la scivolosità. Attualmente non è disponibile un metodo di misura standardizzato a livello internazionale, la maggior parte delle nazioni ha metodi propri derivati da leggi, disposizioni antinfortunistiche o altre regolamentazioni di carattere nazionale. Per aver un buon risultato, il valore medio del coefficiente di attrito dinamico deve essere: $\mu > 0,40$, $R \geq R9$ e $\mu \geq A$.

Qui di seguito riportiamo la sintesi degli indicatori che misurano la resistenza alla scivolosità:

R: indica l'angolo di inclinazione raggiunto nel test di prova

V: rappresenta lo spazio di deflusso determinato dai rilievi della superficie

A.B.C.: sono riferimenti di resistenza alla scivolosità relativa ad ambienti umidi e a piedi nudi.

SLIP RESISTANCE

Slip resistance is a characteristic that affects the health and safety of users in the case of flooring. Slippery surfaces are potential causes of accidents, also serious in nature, in civil environments and in workplaces. The parameter that measures slip resistance is the coefficient of friction (static or dynamic); the force required for relative movement between two bodies (and therefore also the force defining the equilibrium condition). Said force, being parallel to the contact surface, is proportional to the coefficient of friction. The higher the coefficient of friction, the less slippery the surface.

A standardized international measurement is not currently available and most countries have their own measurement methods based on laws, safety regulations or other national legislation. For good results, the average dynamic friction coefficient must be: $\mu > 0,40$, $R \geq R9$ and $\mu \geq A$.

The following is a short description of the indicators used to measure slip resistance:

R: the angle of slope attained during the test

V: the displacement space calculated from the surface relief pattern

A.B.C.: slip resistance ratings for a barefoot operator on a wet surface.

GLISSANCE

La résistance à la glissance des revêtements de sol est une caractéristique très importante pour la sécurité et la santé des utilisateurs. Les surfaces glissantes sont des causes potentielles d'accidents, même graves, dans le domaine civil comme professionnel. La grandeur qui quantifie la résistance à la glissance est le coefficient de frottement (statique ou dynamique), auquel est proportionnelle la force, parallèle à la surface de contact, qui doit être appliquée pour qu'il y ait un mouvement relatif entre deux corps, et donc aussi la force qui en définit les conditions d'équilibre. Plus le coefficient de frottement est élevé, plus la glissance est faible. À l'heure actuelle, il n'existe pas de méthode de mesure normalisée au niveau international. La plupart des pays ont leurs propres méthodes découlant des lois, des règlements de prévention des accidents ou d'autres réglementations nationales. Pour obtenir un bon résultat, la valeur moyenne du coefficient de frottement dynamique, doit être : $\mu > 0,40$, $R \geq R9$ et $\mu \geq A$.

Voici un résumé des indicateurs qui mesurent la résistance à la glissance :

R : indique l'angle d'inclinaison mesurée lors du test

V : représente l'espace d'écoulement créé par les reliefs de la surface

A.B.C. : sont des indicateurs de résistance à la glissance dans les environnements humides et pieds nus.

RUTSCHIGKEIT

Natürlich ist die Rutschfestigkeit eine Eigenschaft, die sich im Bereich der Bodenbeläge auf die Sicherheit und Gesundheit der Anwender auswirkt. Rutschige Oberflächen sind mögliche Ursachen für unter Umständen auch schwere Unfälle sowohl im öffentlichen Bereich als auch im Gewerbebereich. Der Wert, der die Rutschfestigkeit quantifiziert, ist der Reibungskoeffizient (statisch und dynamisch). Zu diesen verhält sich die Kraft proportional, die parallel zur Kontaktfläche wirkt und aufgebracht werden muss, damit eine relative Bewegung zwischen zwei Körpern erfolgt. Somit ist sie auch die Kraft, die die Bedingungen für das Gleichgewicht bestimmt. Je höher der Reibungskoeffizient ist, umso niedriger ist die Rutschigkeit.

Derzeit steht auf internationaler Ebene keine standardisierte Messmethode zur Verfügung.

Der Großteil der Länder besitzt eigene Methoden, die auf Gesetzen, Unfallschutzbestimmungen oder anderen Regelungen nationaler Art beruhen. Um ein gutes Ergebnis zu erzielen, muss der durchschnittliche Wert des dynamischen Reibungskoeffizienten betragen: $\mu > 0,40$, $R \geq R9$ und $\mu \geq A$.

Nachfolgend führen wir eine Zusammenfassung der Indikatoren auf, mit denen die Rutschfestigkeit gemessen wird:

R: gibt den beim Test erreichten Neigungswinkel an

V: bezeichnet den durch die Oberflächenreliefs bestimmten Verdrängungsraum

A.B.C.: bezieht sich auf die Rutschfestigkeit hinsichtlich Barfuß-Nassbereiche.

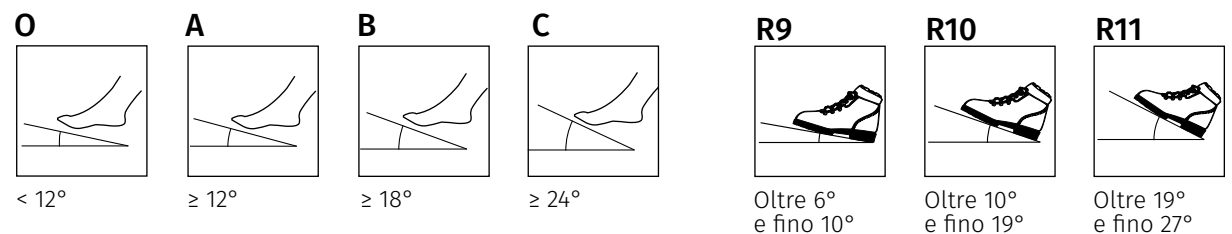

CARATTERISTICHE TECNICHE

Technical Features . Caracteristiques Techniques . Technische Eigenschaften

SUPERFICI

Cir, nell'intento di fornire prodotti adeguati ad ogni tipo di ambiente, produce una vasta gamma di superfici in grado di rispondere ad ogni condizione e necessità d'impiego. Oltre alle superfici classiche, vengono prodotti pavimenti antisdrucciolo sia con la tecnica delle applicazioni superficiali di smalti adeguati, che tramite l'utilizzo di idonei stampi strutturati. Inoltre per ottemperare alla richiesta in tema estetico si forniscono prodotti levigati e/o lappati o con superfici che per loro natura creano disegni o forme esteticamente apprezzabili.

SURFACES

In the drive to supply products that are suitable for all types of environments, Cir produces a very wide range of surfaces capable of meeting all application conditions and requirements. Apart from classic surfaces, the company produces non-slip surfaces through the application of adequate glazes and by using specially designed structured moulds. Also, to comply with aesthetic requirements the company supplies honed and/or polished products or products whose surfaces naturally produce aesthetically appealing designs or shapes.

SURFACES

Cir, afin de fournir des produits appropriés à tous les niveaux d'application, propose une large gamme de surfaces capables de satisfaire à toutes les conditions et exigences. En plus des surfaces classiques, nous réalisons des sols antidérapants moyennant l'application superficielle de revêtements prévus à cet effet ou en utilisant des moules structurés. Encore, afin de répondre aux attentes des clients en matière de design, nous proposons aussi des produits lustrés et/ou polis ou des produits dont les surfaces, de par leur nature, créent des dessins ou des formes particulièrement esthétiques.

OBERFLÄCHEN

Um passende Produkte für alle Einsatzbereiche zu bieten, produziert Cir ein umfangreiches Oberflächensortiment, das allen Bedingungen und Anwendungsbedürfnissen gerecht wird. Zusätzlich zu den klassischen Oberflächen werden rutschfeste Oberflächen produziert, entweder mit der Auftragungstechnik rutschfester Glasuren oder mit strukturierten Stempeln. Außerdem werden zur Erfüllung ästhetischer Ansprüche polierte und/oder geläppte Oberflächen gefertigt, oder solche, die aufgrund ihrer Beschaffenheit Muster oder ästhetisch schätzbare Formen bilden.

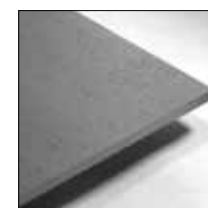

SUPERFICIE NATURALE

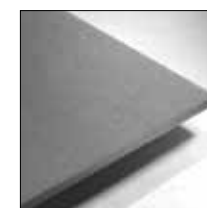

SUPERFICIE NATURALE/RETTIFICATA R11

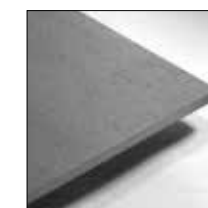

SUPERFICIE NATURALE RETTIFICATA

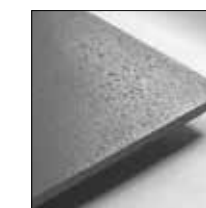

SUPERFICIE LUX

VARIAZIONI DI TONO

Shade variations . Variations de nuance . Tonvariationen

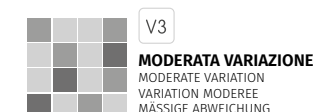

POSE ET ENTRETIEN

Posa e pulizia . Laying and cleaning . Verlegung und Reinigung

CONSEILS POUR LA POSE

La mise en œuvre optimale d'un sol en grès cérame Cir est fonction non seulement des qualités techniques et esthétiques du matériau, mais aussi d'un ensemble d'éléments (sous-couche, couche d'encollage, joints de dilatation, etc.) constituant un véritable système. Les opérations de pose, exécutées dans le bon ordre, doivent être considérées tout aussi importantes que le choix des carreaux.

Pour le choix de la colle la plus appropriée et pour les modalités d'application, il est conseillé de se conformer aux instructions fournies par le fabricant de la colle.

Il est également important de vérifier que les produits à utiliser pour le jointoieiment, s'ils sont très colorés, ne salissent pas la surface des carreaux et que ces salissures sont faciles à éliminer : il est donc recommandé d'effectuer un test avant de commencer le jointoieiment. Pour toute clarification et/ou information, il est conseillé de consulter la division technique de Cir, surtout si le matériau doit être mis en œuvre dans des conditions ambiantes particulières.

Le projet de chaque surface carrelée doit être confié à un concepteur expert qui, selon la structure, l'utilisation prévue des locaux, les charges prévues et les contraintes mécaniques, thermiques, physiques et chimiques auxquelles le carrelage sera soumis, doit dimensionner les sous-couches, les couches de ciment, les couches de chape, les carreaux de céramique, les pentes et l'ensemble du système de pose. En outre, le concepteur doit consigner tous les détails du chantier dans le cahier des charges de pose, notamment le type et le mode de pose, les matériaux, les granulométries, les dosages, les dimensions des joints, des joints structuraux, des joints de dilatation, des joints périphériques, etc.

MODALITÉS DE POSE

- Choisir avec soin les carreaux en fonction des exigences esthétiques et techniques du lieu de pose (style et utilisation prévue des locaux), les formats à poser, le schéma de pose, les dimensions et la couleur des joints.
- Une pose sans joints est fortement déconseillée voire irréalisable en extérieur. En cas de pose modulaire de plusieurs formats, prévoir des joints de :
 - 2 mm pour les articles rectifiés ;
 - 4 ou 5 mm pour les articles NON rectifiés.
- À signaler à la commande : toujours indiquer si le matériau désiré est destiné à une pose multiformat afin de permettre aux bureaux de vente d'envoyer aux clients les calibres et les teintes assortis.
- Le grès cérame Cir peut être posé à l'aide d'un mortier traditionnel ou d'une colle.
- Procéder à la pose dans les « règles de l'art » en suivant les indications du concepteur, du responsable du chantier et du cahier des charges de pose.
- Pour une meilleure gestion du chantier, il est essentiel de respecter les temps de mise en œuvre des matériaux utilisés en suivant les indications fournies par les fabricants.
- Contrôler les matériaux avant la mise en œuvre. Les réclamations concernant des matériaux déjà mis en œuvre, ne seront pas acceptées.
- Poser sur le sol quelques mètres (au moins 3 m²) pour apprécier l'effet global. Poser le matériau en prenant les carreaux de boîtes différentes et en contrôlant soigneusement le calibre, les nuances et la qualité des différentes pièces.
- Le haut degré de vitrification des carreaux de Cir comporte de modestes tolérances de calibre ; c'est pourquoi nous conseillons, lors de la pose, de laisser un joint d'au moins 3 mm entre les carreaux.
- Ne pas marquer la partie supérieure avec des crayons ou des feutres.
- Attendre 48/72 heures avant de circuler sur le carrelage. Les variations chromatiques du produit sont un trait distinctif que seule l'habilité du poseur peut valoiriser pour créer un carrelage unique et incomparable. Un beau produit mal posé ne donne pas un bon résultat esthétique.
- Pose conseillée avec un décalage entre chaque listel n'excédant pas 25 % de la longueur.

CONSEILS POUR LA POSE DES MATÉRIAUX RECTIFIÉS

La pose sans joint du produit rectifié demande une très grande attention et précision de la part de l'installateur pour ce qui est de la planéité du plan de pose et pour la continuité des joints. Pour réaliser une pose parfaite, Cir suggère de maintenir au moins 2 mm de joint pour la pose des monoformats, et pour les combinaisons de formats mixtes.

La pose sans joint, surtout pour ce qui concerne les grands formats, est fortement déconseillée par la plupart des producteurs de colle, pour les motifs suivants :

• difficulté à absorber les éventuels mouvements structuraux en

l'absence d'éléments compressibles ;

- comportement dilatométrique différent entre le carrelage et la chape, en présence de fortes variations de température ;
- difficulté de réalisation d'un jointoieiment efficace et durable. Cir déconseille vivement des poses sans joints. Dès lors, la société ne saurait être tenue pour responsable des conséquences de ce choix. Cir conseille de poser le produit rectifié avec des joints de 2 mm minimum.

JOINTOIEIMENT

- En cas de non-utilisation de coulis à base de ciment et de sable, nous conseillons d'utiliser du mastic dans des couleurs ton sur ton (si possible, pour les matériaux clairs ne pas utiliser de mastics d'une couleur sombre, telle que noir, bleu, rouge).
- Ne jointoyer que lorsque le sol est praticable, en prenant soin d'enlever au préalable tout résidu des joints.
- Effectuer le jointoieiment dans les « règles de l'art », en suivant les prescriptions du concepteur, du responsable du chantier et du cahier des charges de pose.
- Jointoyer des petites portions de surface à la fois (4 à 5 m²) et enlever l'excédent avec des éponges ou des chiffons humides (eau propre uniquement) ou des machines spécialement conçues pour éliminer le mastic en excès.
- Ciments-joints sans adjuvants : à la fin de la journée, nettoyer les résidus de pose à l'aide d'une éponge légèrement humide. Sauf indication contraire du fabricant, le lavage après la pose du carrelage doit être effectué après 4-5 jours (afin de permettre au mastic de sécher). Il faudra d'abord humidifier les joints avec de l'eau pour ensuite recourir à des détergents à base acide spécialement prévus pour ce type d'utilisation. Ne pas attendre trop longtemps avant de procéder au lavage car au bout de deux semaines, il est déjà très difficile d'obtenir des résultats satisfaisants. Ne pas procéder au lavage après la pose si la température des carreaux est élevée. En été, le lavage doit être effectué durant les heures fraîches de la journée.
- Mastics époxy ou avec adjuvants (latex, etc.) : suivre attentivement les indications des fabricants car leur durcissement rapide peut rendre le nettoyage difficile, surtout en présence de carreaux antidérapants, rugueux ou structurés.

NETTOYAGE, PROTECTION ET ENTRETIEN DE ROUTINE DES CARREAUX DE GRÈS CÉRAME

La durabilité d'une surface carrelée dépend également de la manière dont elle est utilisée et entretenue.

Les revêtements de sol et de mur conçus et posés correctement sont des surfaces très résistantes. Cependant, certaines précautions dictées par le bon sens, ainsi que par la connaissance des caractéristiques des matériaux, sont nécessaires.

LAVAGE APRÈS LA POSE

L'importance du lavage après la pose est fondamentale pour garantir la qualité de l'entretien et la maintenance future de votre carrelage.

Le lavage à l'acide, après la pose, permet d'éliminer les résidus de pose et les saouillures que l'on retrouve habituellement sur un chantier telles que : mortier, colle, peinture et tous les types de salissures de chantier .

Nous vous rappelons que plus de 90 % des réclamations sur les chantiers sont dues à un mauvais, voire inexistant, lavage avec un détergent acide après la pose.

Pour éviter qu'un produit à base acide utilisé pour le premier nettoyage n'entame le mortier de jointoieiment, il est nécessaire, avant le nettoyage, de mouiller le sol afin d'imprégner les joints et donc de les protéger des effets corrosifs de l'acide en question. Si le premier nettoyage après la pose doit être effectué peu de temps après l'utilisation du sol, il convient de :

- éliminer auparavant toute trace de graisses ou matières similaires à l'aide de détergents spéciaux à base alcaline
- puis procéder au lavage après pose

Après le lavage, rincer abondamment le sol en recueillant l'eau résiduelle.

Le lavage après la pose doit être fait après le complet séchage du ciment joint (au moins 48 à 72 heures), en suivant scrupuleusement les instructions du mode d'emploi données par le fabricant des détergents.

Le lavage après la pose avec des produits à base d'acide tamponné, appliqués à l'éponge, ne doit être effectué qu'une seule fois et présente en outre l'avantage de donner à la surface une couleur uniforme.

ENTRETIEN COURANT

Il est recommandé d'utiliser un produit détergent ordinaire, neutre et dilué dans de l'eau. Éviter toute utilisation de produits acides, alcalins, à base de cire et/ou d'agents d'imprégnation. Lors du nettoyage de routine, limiter au maximum l'emploi de produits

fortement abrasifs (par exemple, les éponges métalliques, paille de fer ou laine d'acier). Cette précaution devient obligatoire lorsque les carreaux ont une surface brillante, car ils sont plus exposés aux effets visibles des rayures, des éraflures, etc. En cas de saleté plus consistante ou de surfaces particulièrement structurées, il est conseillé d'utiliser un produit détergent à base alcaline en prenant soin de bien rincer en fin de lavage.

Pour les grandes surfaces, il est recommandé d'utiliser des machines lavantes et séchantes.

Dans l'utilisation au quotidien, il convient de tenir compte que certaines saletés (poussière, sable) augmentent l'effet abrasif du trafic piétonnier. Par conséquent, songer à mettre un paillason ou un tapis-brosse à l'entrée afin d'éviter que ce type de saleté ne pénètre de l'extérieur.

ENTRETIEN EXCEPTIONNEL

En cas de saleté résistante au nettoyage de routine, il est recommandé d'utiliser un produit détergent adapté au type de saleté plus persistante.

REVÊTEMENTS DE SOL ET DE MUR MÉTALLISÉS

Pour le nettoyage et l'entretien des carreaux métallisés, il est conseillé de ne pas utiliser de détergents acides ou alcalins. Utiliser exclusivement des produits à PH neutre.

De plus, toujours effectuer un test sur une portion de matériau non posé et éviter de laisser le détergent sur le carrelage pendant plus de 10-15 minutes.

Enfin, toujours rincer abondamment avec de l'eau claire.

RECOMMANDATIONS

Il convient de souligner qu'il ne faut jamais utiliser de détergents à base d'acide fluorhydrique (HF) ou de ses composés, y compris les antirouilles ou les détachants en aérosol qui contiennent souvent cet acide.

Les dommages qui en résulteraient seraient irréparables car aucun sol du marché n'est résistant à cet acide.

MISE EN GARDE

Les caractéristiques de nettoyage des matériaux peuvent varier de façon significative selon les modalités de pose, les conditions d'utilisation, les types de surfaces et de lieux.

En règle générale, plus les caractéristiques antidérapantes des carreaux sont élevées, plus le nettoyage est difficile.

Avant chaque intervention, le professionnel chargé de l'entretien et du nettoyage devra toujours effectuer un contrôle empirique préalable (si possible sur une portion de matériau non posé).

Cir décline toute responsabilité quant à l'efficacité des opérations de nettoyage et d'entretien en cas de pose ou de nettoyages inadéquats, ainsi que dans des conditions d'utilisation particulièrement difficiles. Il est entendu que Cir ne peut être tenu responsable des dommages ou défauts dus à une installation incorrecte, à un nettoyage et un entretien négligents ou à un choix inadéquat du type de matériaux installés et des colles utilisées au vu de leur application.

Tous les renseignements présents dans ce document sont donnés à titre indicatif. Pour de plus amples informations, se reporter à la documentation spécialisée disponible sur les catalogues et les sites Internet des principaux fabricants de produits spécifiques pour le nettoyage des sols, tels que par exemple : Fila Industria Chimica spa (www.filachim.com), Mapei S.p.A (www.mapei.it), Kerakoll S.p.A. (www.kerakollgroup.com), Bonasystems Italia S.r.l. (www.bonasytemsitalia.it), Faber Chimica S.r.l. (www.faberchimica.com), Periscopio s.r.l. (www.periscopiosoluzioni.com).

TRAITEMENT DES PRODUITS LUSTRÉS ET POLIS

Le lustrage et le polissage sont des opérations qui impliquent l'élimination et le polissage de la partie superficielle de l'émail, ou du corps du carreau en question.

Sur tous les sols céramiques disponibles sur le marché, une telle opération, même en présence de matériaux vitreux ou à très faible absorption, peut entraîner l'ouverture de microporosités de surface qui, au contact de certains types de salissures, peuvent être difficiles à nettoyer ou présenter des auroèles difficiles à éliminer.

Cir conseille, après le lavage après pose, qui doit être effectué avec un détergent à base acide, d'appliquer une protection antitache avec des produits certifiés, afin d'éviter que le matériau puisse absorber les taches tout en conservant les caractéristiques esthétiques et techniques du grès cérame.

Nous vous rappelons que quel que soit le traitement effectué par le producteur avant la pose, celui-ci sera totalement éliminé par le lavage à base acide qui devra être effectué après la pose et donc, aucune efficacité antitache ne pourra être garantie.

VERLEGUNG UND REINIGUNG

Posa e pulizia . Laying and cleaning . Pose et entretien

VERLEGEHINWEISE

Die einwandfreie Verlegung eines Bodens mit Feinsteinzeug von Cir ist nicht nur auf die technischen und ästhetischen Eigenschaften des Produkts, sondern auch auf die gesamten Elemente (Untergrund, Bideschicht, Dehnfugen, usw.) zurückzuführen, die ein wahres System bilden. Auch die in korrekter Reihenfolge durchgeführten Verlegevorgänge sind genauso wie die Auswahl der Fliesen selbst als wichtig zu betrachten. Für die Auswahl des am besten dazupassenden Klebers und für die technische Anweisungen wird empfohlen, die Hinweise des Kleberherstellers zu beachten. Es ist auch wichtig zu prüfen, dass die zum Verfügen verwendeten Produkte, falls sie sehr gefärbt sind, die Oberflächen der Fliesen nicht verschmutzen und dass dieser Schmutz leicht zu entfernen ist: Es ist daher ratsam, vor Beginn des Verfügens einen Test durchzuführen. Für Klärungen und/oder Informationen kann man sich an die technische Abteilung von Cir wenden, insbesondere wenn das Material unter besonderen Umgebungsbedingungen verlegt werden soll. Die Planung einer gefliesten Oberfläche sollte vorzugsweise einem Planungsfachmann anvertraut werden, der - unter Berücksichtigung von Struktur, Verwendungszweck der Räume, vorgesehener Belastung, mechanischer, thermischer, physikalischer und chemischer Beanspruchung des Fußbodens - den Untergrund, den Zementestrich, die Einbettung, die Keramikfliesen, die Neigung und das gesamte Verlegungssystem genau bemessen muss. Darüber hinaus muss der Planungsfachmann im Leistungsverzeichnis jede Baustellenspezifikation angeben, darunter die Art und Vorgehensweise der Verlegung, die Materialien, Granulometrie, Dosierungen, Fugengröße, Struktur-, Dehnungs- und Randfugen, usw.

VERLEGUNGSARBEITEN

- Wählen Sie die genau passenden ästhetischen und technischen Anforderungen der Fliesen sorgfältig aus (im Verhältnis zum Stil und zum Verwendungszweck der Räume), und bestimmen Sie die zu verlegenden Formate, das Verlegungsmuster, die Breite und die Farbe der Fugen.
- Vom Verlegen ohne Fugenabstand wird völlig abgeraten und ist in Außenbereichen sogar grundsätzlich nicht möglich. Sollten Sie Fliesen verschiedener Größen modular verlegen wollen, sind folgende Fugenbreiten vorzusehen:
 - 2 mm für rektifizierte Fliesen;
 - 4 oder 5 mm für NICHT rektifizierte Fliesen.
- Angaben bei Auftragserteilung: Bitte immer genau angeben, ob der gewünschte Bodenbelag im Multiformat verlegt werden soll, um es den Verkaufsbüros zu ermöglichen, Ihnen die Fliesen mit der richtig passenden Maß- und Farbtonkombinierung zu liefern.
- Das Feinsteinzeug von Cir kann sowohl im herkömmlichem Mörtel als auch mit Fliesenkleber verlegt werden.
- Verlegen Sie die Fliesen fachgerecht und beachten Sie dabei die Anweisungen des Planungsfachmanns, des Bauleiters und des Leistungsverzeichnisses.
- Um einen reibungslosen Ablauf auf der Baustelle zu gewährleisten, ist es von besonderer Bedeutung, die verwendeten Materialien gemäß Verlegezeiten und unter Befolgung der Anweisungen der Hersteller zu verarbeiten.
- Das Material vor der Verlegung prüfen. Reklamationen für bereits verlegte Produkte werden nicht akzeptiert.
- Eine kleine Fläche (mindestens 3 m2) auf dem Boden ausbreiten, um die Gesamtwirkung zu kontrollieren. Wir empfehlen, die zu verlegenden Fliesen aus mehreren Kartons zu nehmen und sorgfältig auf Werkmaß, Farbton und Sorte zu überprüfen.
- Der hohe Sinterungsgrad der Fliesen von Cir ermöglicht sehr geringere Werkmaßtoleranzen: Deshalb wird eine Fuge von mindestens 3 mm zwischen den Fliesen empfohlen.
- Blei- oder Filzstifte auf der Oberseite der Fliesen nicht benutzen.
- Vor der normalen Begehung des Bodens 48/72 Stunden warten. Das Farbspiel des Produkts ist eine qualifizierende Eigenschaft, die ein fähiger Fliesenleger hervorheben kann. Ein schönes aber schlecht verlegtes Produkt bietet kein ästhetisch gutes Ergebnis.
- Es wird empfohlen, die Listellos um nicht mehr als 25% ihrer Länge versetzt zu verlegen.

VERLEGUNGSHINWEISE FÜR REKTIFIZIERTE MATERIALIEN

Die angesetzte Verlegung mit nicht geschlossener Verbindung des rektifizierten Produkts verlangt seitens des Fliesenlegers eine größere Aufmerksamkeit und Genauigkeit bezüglich der Ebenheit der Verlegungsfläche und der Kontinuität des Fugenbildes. Um eine optimale Wirkung zu erzielen, empfiehlt Cir eine mindestens 2 mm breite Fuge bei Verlegungen in einem Format und bei Formatkombinationen. Die Verlegung mit geschlossener Verbindung, insbesondere der großen Formate, wird von den meisten Klebstoffherstellern aus folgenden Gründen nicht empfohlen:

• Schwierigkeiten bei der Absorption eventueller

Bodenbewegungen ohne komprimierbare Elemente;

- Unterschiedliche Ausdehnung zwischen Fliesen und Mörtelbett bei hoher Temperaturschwankung;
- Schwierigkeiten bei der Realisierung von wirksamen, dauerhaften Fugen.

Cir rät dringendst von einem fugenlosen Verlegen ab und lehnt jede Haftung dafür ab.

Cir empfiehlt, die rektifizierten Fliesen mit einer Fuge von mindestens 2 mm zu verlegen.

VERFUGUNG

- Wenn kein Fugenmörtel aus Zement und Sand benützt wird, wird zur Verwendung von Fugenmassen in ähnlicher Tonalität empfohlen (wenn möglich, keine dunkle Fugenmasse wie z.B. schwarz, dunkelblau, rot für helle Fliesenoberflächen verwenden).
- Verspachteln Sie die Fugen erst dann, wenn die Bodenfliesen begehbar sind, nach einer vorherigen Entfernung von jeglichen Rückständen.
- Führen Sie die Spachtelarbeiten fachgerecht aus und befolgen Sie dabei die Anweisungen des Planungsfachmanns, des Bauleiters und des Leistungsverzeichnisses.
- Immer jeweils kleine Flächen (4-5 m2) verfügen und sofort die überflüssige Fugenmasse mit einem feuchten Lappen oder Schwamm (nur mit klarem Wasser) entfernen oder entsprechende Reinigungsmaschinen verwenden.
- Zementär-Fugenmassen ohne Zuschläge: Befreien Sie am Ende des Tages die Fliesen von den Rückständen der Verlegearbeiten mit einem leicht angefeuchteten Schwamm. Die Reinigung des Fußbodens nach dem Verlegen sollte, sofern der Hersteller keine anderen Angaben gemacht hat, 4-5 Tage später erfolgen (die Spachtelmasse hat dadurch genügend Zeit, um auszuhärten); befeuchten Sie hierzu zuerst die Fugen mit Wasser und verwenden dann ein geeignetes Reinigungsmittel auf Säurebasis. Warten Sie nicht zu lange mit der Reinigung, da sie bereits nach zwei Wochen sehr viel mehr Arbeitseinsatz erfordern wird. Führen Sie die Reinigung nach dem Verlegen nicht durch, wenn die Temperatur der Fliesen erhöht ist; im Sommer z.B. sollten Sie die Reinigungsarbeiten entweder in den noch kühlen Morgen- oder Abendstunden vornehmen.
- Epoxydharz-Fugenmassen bzw. Fugenmassen mit Zuschlägen (mit Latex etc.): Befolgen Sie sorgfältig die Anweisungen des Herstellers, da das schnelle Aushärten dieser Fugenmaterialien sehr aufwendige Säuberungsarbeiten nach sich ziehen kann, besonders wenn die Fliesenoberfläche rutschfest, rau oder strukturiert ist.

REINIGUNG UND ROUTINE-SCHUTZBEHANDLUNGEN VON FEINSTEINZEUGFLIESEN

Die Dauer eines Fliesenbelages hängt auch davon ab, wie er verwendet und gepflegt wird. Gut geplante und verlegte Wand- und Bodenverfliesungen sind sehr widerstandsfähig.

Es sind jedoch einige vernünftige Vorsichtsmaßnahmen sowie die Kenntnis der Eigenschaften der Materialien erforderlich.

ERSTREINIGUNG NACH DER VERLEGUNG

Die Erstreinigung nach der Verlegung ist von ausschlaggebender Bedeutung für alle darauffolgenden Arbeiten und für die Pflege des Bodenbelages.

Eine Absäuerung nach der Verlegung entfernt Verlegungsreste und den normalen Baustellenschmutz, wie Zementschleier, Kleber, Farbe und Baustellenschmutz verschiedener Art. Es ist wichtig zu wissen, dass über 90% der Reklamationen auf der Baustelle auf eine nicht fachgerechte oder überhaupt nicht erfolgte Reinigung nach dem Verlegen mit einem säurehaltigen Reinigungsmittel zurückzuführen sind. Um zu verhindern, dass ein für die Erstreinigung verwendetes säurehaltiges Reinigungsmittel die Fugen auf Zementbasis angreift, ist es notwendig, den Boden vor der Reinigung mit Wasser nass zu machen, um die Fugen zu imprägnieren und vor der korrosiven Wirkung der Säure zu schützen. Falls die Erstreinigung kurz nach der ersten Benutzung des Bodenbelages durchgeführt werden soll, sollte man zuerst ein Reinigungsmittel auf alkalischer Basis verwenden, um Öle und Fette zu entfernen. Danach kann die Erstreinigung erfolgen. Zum Schluss den Belag gründlich mit Wasser abspülen und die Wasserrückstände entfernen.

Die Bauendreinigung nach Abschluss der Baustellenarbeiten ist erst nach vollständigem Trocknen der Zementär-Fugenmasse (mindestens 48-72 Stunden) vorzunehmen, unter skrupelhafter Befolgung der Empfehlungen des Herstellers der Reinigungsmittel. Die Bauendreinigung mit Produkten auf Säurebasis sollte in der Regel nur einmal durchgeführt werden, und hat den weiteren Vorteil, der gesamten Oberfläche chromatische Einheitlichkeit zu verleihen.

UNTERHALTSREINIGUNG

Es wird empfohlen, neutrale Reinigungsmittel im Wasser

verdünnt zu verwenden. Säurehaltige und alkalische Produkte, Wachs- und/oder Imprägnierungsmittel sind zu vermeiden, und die Verwendung von Schleifmitteln wie z.B. Metallkratzer, Eisen- und Stahlschwämme sollte so weit wie möglich eingeschränkt werden.

Wenn es sich um polierte Fliesenoberflächen handelt, wird diese Vorsichtsmaßnahme zur Pflicht, da sie sichtbaren Auswirkungen wie Kerben und Kratzern stärker ausgesetzt sind.

Auf besonders strukturierten Oberflächen oder stark verschmutzen Belägen wird ein Reinigungsmittel auf alkalischer Basis empfohlen; danach reichlich mit Wasser abspülen.

Für Großflächen empfehlen wir den Einsatz von Maschinen.

Es ist ebenfalls zu berücksichtigen, dass eine besondere Art von Schmutz (wie Sand und Staub) die Abriebwirkung des Fußgängerverkehrs erhöhen. Versuchen Sie daher, das Vorhandensein dieser Art von Schmutz von außen zu verhindern, indem Sie am Hauseingang eine Fußmatte auslegen.

GRUNDREINIGUNG

Falls die normalen Reinigungsmittel in besonderen Fällen unwirksam sein sollten, wird je nach Art der Verschmutzung das entsprechend geeignete Reinigungsmittel empfohlen.

BÖDEN UND VERKLEIDUNGEN MIT METALLISierter OBERFLÄCHE

Für die Reinigung und Pflege metallisierter Fliesen, auf keinen Fall saure oder alkalische Reinigungsmittel verwenden. Nur PH-neutrale Reinigungsmittel benutzen.

Es ist empfehlenswert, das Reinigungsmittel grundsätzlich auf einigen nicht verlegten Fliesen zu testen, und nicht länger als 10-15 min das Mittel auf der Oberfläche zu lassen. Danach, wie üblich mit Wasser reichlich abwaschen.

WEITERE EMPFEHLUNGEN

Wir weisen darauf hin, auf KEINEN Fall Reinigungsmittel auf Flusssäure-Basis (HF) oder deren Verbindungen zu verwenden, inkl. Rostschutzmittel oder Fleckentferner aus der Spraydose, in denen sie oft enthalten ist. Der dadurch entstandene Schaden wird permanent bleiben, da alle auf dem Markt erhältlichen Fliesen gegen diese Säure absolut nicht widerstandsfähig sind.

HINWEISE

Die Reinigungseigenschaften der Fliesen ändern sich je nach Art der Verlegung, Benutzung, Oberfläche und Umgebung bedeutend.

In der Regel steigt mit zunehmender Rutschhemmung der Fliesen auch die Schwierigkeit der Reinigung.

Der für die Instandhaltungs- und Reinigungsarbeiten zuständige Facharbeiter muss immer eine empirische Vorabkontrolle für jede einzelne Art von Eingriff durchführen, möglicherweise an einem Teil des nicht verlegten Materials. Bei besonders schwierigen Einsatzbedingungen, falscher Verlegung oder unsachgemäß ausgeführter Reinigung übernimmt Cir keine Verantwortung für die Wirksamkeit von Reinigungs- und Pflegearbeiten. In keinem Fall ist Cir für eventuelle Schäden oder Mängel verantwortlich, die auf eine falsche Verlegung, nachlässige Reinigung und Pflege oder auf eine ungeeignete Auswahl der verlegten Materialien und verwendeten Kleber für die jeweilige Gebrauchsbestimmung zurückzuführen sind.

Die in diesem Abschnitt enthaltenen Informationen sind vollkommen unverbindlich.

Für weitere Informationen verweisen wir auf die entsprechende Dokumentation, die in den Katalogen und Websites der wichtigsten Hersteller spezifischer Bodenreiniger enthalten sind, wie z.B.: Fila Industria Chimica spa (www.filachim.com), Mapei S.p.A. (www.mapei.it), Kerakoll S.p.A. (www.kerakollgroup.com), Bonasystems Italia S.r.l. (www.bonasytemsitalia.it), Faber Chimica S.r.l. (www.faberchimica.com), Periscopio s.r.l. (www.periscopiosoluzioni.com).

BEHANDLUNG VON GELÄPPTEN UND POLIERTEN MATERIALIEN

Läppen und Polieren sind Anfertungsverfahren, die das Entfernen und Polieren des oberflächlichen Teils der Glasur oder des Fliesenkörpers beinhalten. Bei allen Keramikfliesen auf dem Markt, nach dieses Verfahren - auch bei Materialien mit extrem niedriger Wasseraufnahme oder glasieriger Oberfläche - zur Öffnung von Mikroporositäten auf der Oberfläche führen, die bei Kontakt mit bestimmten Arten von Schmutz schwer zu reinigen sind oder schwer zu entfernende Schlieren bilden.

Cir empfiehlt, nach der Erstreinigung, die mit einem Reinigungsmittel auf Säurebasis (wie oben angegeben) durchzuführen ist, einen Fleckschutz mit zertifizierten Produkten aufzutragen, um zu verhindern, dass Flecken in die Fliesenoberfläche eindringen, sodass die ästhetischen und technischen Eigenschaften des Feinsteinzeugs unverändert bleiben.

Wir möchten darauf aufmerksam machen, dass jegliche Behandlung, die vom Hersteller vor der Verlegung gemacht werden sollte, durch die Erstreinigung nach der Verlegung mit säurehaltigen Reinigungsmitteln komplett entfernt wird, sodass keine Fleckschutzwirkung garantiert werden kann.

PRODOTTI PER LA PULIZIA E LA MANUTENZIONE*

Cleaning and maintenance products* . Produits de nettoyage et d'entretien* . Produkte zur Reinigung und Pflege*

Salvo diversa indicazione in tabella, per l'utilizzo dei detergenti in elenco seguire attentamente le indicazioni riportate sulle confezioni. Unless otherwise indicated in the table, when using the detergents listed, follow the instructions on the pack carefully.

Sauf mention contraire dan le tableau, pour l'utilisation de détergents repris dans la liste, suivre attentivement les recommandations d'usage figurant sur l'emballage du produit.

Solange die Tabelle keine anderweitigen Angaben enthält, befolgen Sie bei der Verwendung von Reinigungsmitteln sorgfältig die Anweisungen auf den Verpackungen.

Tipo di sporco Type of dirt Type de salete Schmutzart	Tipo di detergente Type of detergent Type de detergent Art des Reinigungsmittels	Nome detergenti Name of detergent Nom du detergent Name des Reinigungsmittels	Produttore Manufacturer Fabricant Hersteller
Cemento, calce, stucchi cementizi, ruggine Cement, lime, cement-based grouts, rust Ciment, chaux, enduits de ciment, rouille Zement, Kalk, Zementspachtelmasse, Rost	A base acida Acid-based A base acide Auf Säurebasis	DETERDEK DELTA PLUS CEMENT KERANET XTREME GRES CLEANER BONA CLEAN	FILA KERAKOLL FABER CHIMICA MAPEI PERISCOPIO BONASYSTEM
Stucco epossidico Epoxy-based grouts Mastic époxy résiduelle Reste von Epoxidfugenmaterial	A base alcalina Alkali-based A base alcaline Auf alkalischer Basis	FILA CR10 FUGALITE GRAFFITI REMOVER KERAPOXY XTREME EPOXY CLEANER BONA DECON	FILA KERAKOLL FABER CHIMICA MAPEI PERISCOPIO BONASYSTEM
Vino, caffè, bibite, succhi di frutta Wine, coffee, soft drinks, fruit juice Vin, café, boissons, jus de fruits Wein, Kaffee, Getränke, Fruchtsäfte	Polifunzionali, a base alcalina Multi-purpose, alkali-based Multifonction, à base alcaline Alkalische Allzweckreiniger	FILA PS87 COLOURED STAIN REMOVER XTREME ALKALINE BONA DECON	FILA FABER CHIMICA PERISCOPIO BONASYSTEM
Pneumatici Tyremarks Pneumatiques Reifenschmutz	A base alcalina Alkali-based A base alcaline Auf alkalischer Basis	FILA PS87 GRAFFITI REMOVER XTREME ALKALINE BONA DECON	FILA FABER CHIMICA PERISCOPIO BONASYSTEM
Cere, grassi Wax, fats Cires, graisses Wachs, Fett	A base solvente Solvent-based A base de solvant Auf Lösungsmittelbasis	FILA SOLV WAX REMOVER XTREME EPOXY CLEANER BONA DECON	FILA FABER CHIMICA PERISCOPIO BONASYSTEM
Patine lasciate da detergenti Residue left by detergents Patines laissées par des nettoyeurs Schleier aus Reinigungsmittelrückständen	Polifunzionali, a base alcalina Multi-purpose, alkali-based Multifonction, à base alcaline Alkalische Allzweckreiniger	FILA PS87 THE CLEANER XTREME ALKALINE BONA DECON	FILA FABER CHIMICA PERISCOPIO BONASYSTEM
Segni di matita, segni metallici Pencil marks, metallic marks Traces de crayon, traces métalliques Bleistift- und metallische Rückstände	A base acida Acid-based A base acide Auf Säurebasis	DETERDEK CEMENT REMOVER XTREME GRES CLEANER BONA CLEAN	FILA FABER CHIMICA PERISCOPIO BONASYSTEM
Inchiostri, pennarello Ink, marker pens Encres, marqueurs Tinte, Filzstift	A base alcalina Alkali-based A base alcaline Auf alkalischer Basis	FILA PS87 - FILA SR95 COLOURED STAIN REMOVER XTREME EPOXY CLEANER BONA DECON	FILA FABER CHIMICA PERISCOPIO BONASYSTEM
Pulizie quotidiane Everyday cleaning Nettoyage quotidien Tägliche Reinigung	Neutro o alcalino Neutral or alkaline Neutre ou alcalin Neutral-oder alkalische Reiniger	FILA CLEANER FLOOR CLEANER EVERY FLOOR BONAMAIN +	FILA FABER CHIMICA PERISCOPIO BONASYSTEM

* Eseguire sempre test preventivo sulle piastrelle prima dell'uso, in particolare su prodotti lappati o levigati.

* Always do a test in advance on the tiles before use, particularly on Lapper or Ground products.

* Toujours procéder à un essai sur les carreaux avant l'utilisation, surtout pour les articles rodés ou polis.

* Vor der Benutzung sollten Sie immer erst einen prophylaktischen Probeauftrag durchführen, besonders auf geläpften oder polierten Fliesen.

BONASYSTEMS Italia S.r.l.
Via Borgo S. Chiara, 29 - 30020 Torre di Mosto (VE) ITALY
Tel +39 0421 325691 - www.bonasytemsitalia.it

FABER CHIMICA S.r.l.
Via G. Ceresani, 10 - Località Campo d'Olmo - 60044 Fabriano (AN) - ITALY
Tel. +39 0732-627178 - www.faberchimica.com

FILA Industria Chimica S.p.A.
Via Garibaldi, 32 - 35018 San Martino di Lupari (Padova) - ITALY
Tel. 049.946.73.00 - www.filachim.com

MAPEI S.p.A.
Via Cafiero 22 - 20153 Milano - ITALY
Tel. +39 02-37673 - www.mapei.it

PERISCOPIO s.r.l.
Sede legale. Via Rainusso n. 90 - 41124 Modena
Sede operativa. Via S.Maria 11 - 41013 Castelfranco Emilia (MO)
Tel. +39 335360913 - www.periscopiosoluzioni.com

KERAKOLL S.p.A.
Via dell'Artigianato 9 - 41049 Sassuolo (MO) - ITALY
Tel +39 0536 816 511 - www.kerakollgroup.com

CONDIZIONI GENERALI DI VENDITA

General terms of sale . Conditions generales de vente . Allgemeine Verkaufsbedingungen

1. NORMATIVA CONTRATTUALE - Le presenti condizioni generali, salvo eventuali modificazioni o deroghe concordate per iscritto, disciplinano tutti i contratti di vendita tra noi e l'acquirente, quindi tanto il contratto concluso con l'accettazione del presente ordine che qualsiasi contratto futuro relativo alle forniture dei prodotti della nostra società ordinati con successive e distinte commissioni.

2. FORNITURE - Il prezzo qui specificato si intende al netto di spese di trasporto, IVA ed eventuali diritti di dogana; per merce resa franco ns. stabilimento.

3. ORDINI - Il Committente si obbliga a mantenere ferma la proposta d'ordine rilasciata a personale commerciale della ns. società. Ogni ordine trasmesso dai ns. Agenti è sempre raccolto "SALVO APPROVAZIONE DELLA CASA", per cui ci riserviamo di non accettare o modificare l'ordine stesso. Quanto sopra vale anche per eventuali cessioni gratuite per sala mostra. Prima di evadere gli ordini, l'azienda si riserva la facoltà di richiedere informazioni commerciali.

4. CONSEGNE - I termini di consegna non sono mai impegnativi; comunque, il mancato espletamento dell'ordine se confermato o il ritardo nella sua esecuzione escludono ogni ns. responsabilità da cause a noi imputabili, quali impedimenti o difficoltà nei trasporti, scioperi, serrate, impossibilità o anche soltanto difficoltà di tempestivo approvvigionamento delle materie prime. Il committente, quindi, non può in nessun caso chiedere la risoluzione del contratto o esigere indennizzi da eventuali danni diretti o indiretti per il ritardo nella consegna.

5. SCELTE - Il materiale verrà consegnato nelle scelte ordinate. Pertanto, le richieste di determinate percentuali di scelta verranno intese come semplici indicazioni e soddisfatte compatibilmente con le rese di produzione.

6. TRASPORTO - La merce viaggia a rischio e pericolo del Committente anche se resa franco destino e la ns. responsabilità cessa con la consegna al vettore, per tanto, i reclami per eventuali ammanchi o rotture dovranno essere rivolti esclusivamente a questi.

7. PREZZI - Ci riserviamo la facoltà di modificare i prezzi del presente listino con un preavviso di 30 (trenta) giorni.

8. PAGAMENTI - I pagamenti devono pervenire presso la ns. sede. L'accettazione da parte ns. di effetti o assegni emessi fuori piazza o comunque il convenuto pagamento a mezzo tratte non deroga tale condizione. Le fatture non contestate entro 8 (otto) giorni dal ricevimento si intendono accettate. I pagamenti dovranno avvenire nei modi e nei termini pattuiti nella ns. commissione. In caso di ritardato pagamento di somme a noi dovute, è ns. facoltà sospendere le forniture e annullare i rapporti in corso. Gli interessi per ritardato pagamento dovranno essere convenuti espressamente con tassi da definire. In difetto verranno applicati gli interessi moratori di legge.

9. CONTESTAZIONE PER VIZI - Eventuali contestazioni per vizi qualsiasi sia palesi sia occulti della merce oggetto della fornitura devono essere inoltrate alla ns. sede a mezzo raccomandata con avviso di ricevimento entro 8 (otto) giorni dal ricevimento della merce. In ogni caso, prima di procedere alla posa del materiale ceramico compravenduto sarà onere dell'acquirente e/o del cliente finale a cui tale obbligazione dovrà essere contrattualmente estesa, verificare la sussistenza o meno di vizi e/o difetti palesi e ciò al fine di non aggravare il danno. Eventuali reclami che dovessero riguardare il materiale già in opera verranno pertanto respinti. La posa in opera determinerà rinuncia alla garanzia per vizi palesi della merce fornita e comunque integrerà quanto disposto dall'art.1227 c.c.. E' espressamente esclusa la garanzia per la merce classificata di seconda o terza scelta, blocchi o partite occasionali. Offerte, transazioni, accrediti concessi dai ns. Agenti o intermediari non sono validi se non confermati per iscritto dalla ns. sede. I nostri campioni sono soltanto indicativi e vengono da noi presentati al solo scopo di fornire al cliente indicazioni di massima del prodotto.

10. SOLVE ET REPETE - Nessuna eccezione, salvo quelle di nullità, annullabilità e rescissione del contratto, può essere opposta dall'acquirente al fine di ritardare od evitare il pagamento.

11. RISERVATO DOMINIO - La vendita della merce viene effettuata con la clausola del riservato dominio, sicchè la proprietà della stessa passerà all'acquirente solo con l'integrale ed effettivo pagamento del prezzo. Il mancato pagamento anche di una sola rata produrrà lo scioglimento del contratto con la facoltà di esigere l'immediato pagamento di tutte le rate anche non scadute ovvero l'immediata restituzione della merce. In tal caso le somme versate resteranno acquisite al venditore a titolo di indennità.

12. CLAUSOLA COMPROMISSORIA - Ad eccezione delle controversie inerenti il pagamento del prezzo ed alle relative azioni esercitate in via monitoria o nel giudizio ordinario, che rimangono di competenza dell'autorità giurisdizionale italiana, qualunque altra controversia che dovesse insorgere in ordine alla conclusione e/o esecuzione e/o risoluzione e/o interpretazione del presente contratto sarà devoluta ad un collegio di tre arbitri, nominati uno da ciascuna delle parti, ed il terzo di comune accordo o, in caso di disaccordo, dal Presidente della C.C.I.A.A. di Reggio Emilia, a richiesta della parte più diligente. La parte che intende avviare l'arbitrato deve comunicarlo all'altra parte con lettera raccomandata contenente la nomina del proprio arbitro e la sua accettazione. L'altra parte dovrà nominare il proprio arbitro nel termine di 15 giorni dalla data di ricezione della raccomandata, comunicando tale nomina e la relativa accettazione entro il termine indicato. In difetto l'alta parte potrà richiedere la nomina del secondo arbitro al Presidente della C.C.I.A.A. di Reggio Emilia. Gli arbitri decideranno secondo diritto e nel rispetto del principio del contraddittorio; il lodo dovrà essere deliberato nel termine di 90 giorni decorrenti dalla data di accettazione dell'ultimo arbitro. L'arbitrato avrà sede in Reggio Emilia.

13. FORO COMPETENTE E LEGGE APPLICABILE - Per qualsiasi controversia è esclusivamente competente il Foro di Reggio Emilia e la legge applicabile è esclusi vamente quella italiana.

14. EFFETTIVITA' DI CIASCUNA CONDIZIONE - Le condizioni generali di vendita sopra riportate non devono assolutamente intendersi come clausole di puro stile. Esse sono effettive e rappresentano fedelmente la volontà negoziale delle parti.

15. RICEZIONE MERCE - Alla ricezione della merce, il cliente è tenuto a verificare che il prodotto consegnato sia conforme a quanto dichiarato nel d.D.T. (Documento di trasporto). Non si accettano reclami per materiale consegnato in cantiere in difformità. Da quanto riportato nel documento stesso. Qualora fosse riscontrata difformità, il gruppo romani si assumerà. I costi di trasporto per l'eventuale sostituzione/integrazione della quantità di prodotto non conforme. Per ogni richiesta di reso dovuta ad errori di ordine, rinuncia da parte del cliente o comunque per motivi non imputabili all'azienda. Sarà richiesto un contributo pari al 10% del valore della merce resa.

GENERAL TERMS OF SALE

Condizioni generali di vendita . Conditions generales de vente . Allgemeine Verkaufsbedingungen

1. CONTRACTUAL REGULATIONS - Subject to possible amendments or exceptions agreed in writing, these general terms govern all sales agreements between our company and the purchaser, meaning both the contract entered into with acceptance of this order and any future agreements related to supplies of our company's products with any future and separate orders.

2. SUPPLIES - The price set forth herein is understood as net of transport costs, VAT and any customs duties, for goods delivered ex works our factory.

3. ORDERS - The customer undertakes to maintain as valid the order proposal issued to our company's sales personnel. Each order sent by our Agents is always accepted "SUBJECT TO COMPANY APPROVAL", and we therefore reserve the right to refuse or amend orders. The above also holds true for any material supplied free-of-charge for showroom use. Before fulfilling orders, the company reserves the right to request commercial details.

4. DELIVERIES - Delivery terms are never binding; in any event, our company cannot be held responsible for any delays in the delivery or fulfilment of orders, where confirmed, due to events beyond our control, such as obstacles or difficulties in transport, strikes, lockouts, impossibility or even merely difficulty in the timely procurement of raw materials. The customer, therefore, cannot in any case request termination of the contract or claim compensation for any direct or indirect damages due to delayed delivery.

5. QUALITY GRADES - The material will be delivered in the ordered quality grades. Requests for specific percentages of different quality grades will be construed as simple indications and fulfilled according to production outputs.

6. TRANSPORT - Goods travel at the customer's risk even if delivered carriage paid and our responsibility ceases with delivery to the carrier; therefore, claims concerning shortfalls or breakages must be made exclusively to the carrier.

7. PRICES - We reserve the right to change the prices in the price-list with 30 (thirty) days' advance notice.

8. PAYMENTS - Payments must be made to our head office. Our acceptance of bills or non-locally issued cheques or in any case agreed payment by banker's drafts does not create an exception to this condition. Invoices not disputed within 8 (eight) days from receipt are considered to be accepted. Payments must be made in the ways and under the terms agreed in our order form. In the case of late payment of sums owed to us, we are entitled to suspend supplies and withdraw from any ongoing relationships. Interest for late payment must be expressly agreed, with rates to be defined. If no such agreement is entered into, legal default interest will be applied.

9. CONTESTED DEFECTS - Any contested apparent or hidden defects of the goods that are the subject of the supply must be referred to our head office by registered letter with return receipt within 8 (eight) days from receipt of the goods. In any case, before laying the ceramic materials purchased it is the responsibility of the purchaser and/or of the end customer, to whom this obligation must be contractually extended, to check for the existence of apparent faults and/or defects, in order to limit any ensuing losses. Any claims concerning material already laid will therefore be rejected. Laying of the material will constitute waiver of warranty for apparent defects in the goods supplied and will anyway supplement the provisions of Article 1227 of the Italian Civil Code. The warranty is expressly excluded for goods classified second or third quality grade, and occasional sales of job lots or batches. Offers, transactions and credits granted by our Agents or intermediaries are not valid unless confirmed in writing by our head office. Our samples are only guideline and we supply them for the sole purpose of providing the client with a general idea of the product.

10. SOLVE ET REPETE - No exception, save that of nullity, possibility of cancellation, and termination of the contract, can be claimed by the purchaser with in order to delay or avoid payment.

11. TITLE RETENTION - Sale of the goods is carried out with the title retention clause, so that ownership of the goods shall pass to the purchaser only upon complete and effective payment of the price. Failure to pay even a single instalment will cause termination of the contract with the right to demand immediate payment of all outstanding instalments even if not due, or immediate return of the goods. In the latter case the seller shall retain the amounts already paid, by way of indemnity.

12. ARBITRATION CLAUSE - Except for disputes relating to payment of the price and the related actions brought in summary proceedings or in the ordinary court, which fall under the competence of the Italian legal authorities, any other dispute that may arise concerning the execution and/or performance and/or termination and/or interpretation of this contract shall be transferred to a board of three arbitrators, one appointed by each of the two parties and the third by common agreement or, in the case of disagreement, by the Chairman of the Reggio Emilia Chamber of Commerce, Industry, Agriculture and Small Business (C.C.I.A.A.), on request of the more diligent party. The party that intends to start arbitration must notify the other party by means of a registered letter containing the appointment of its own arbitrator and his/her acceptance. The other party must appoint its own arbitrator within 15 days from the date of receipt of the registered letter, notifying this appointment and related acceptance within the time-limit indicated. If such action is not taken, the other party may request the Chairman of the Reggio Emilia C.C.I.A.A. to appoint the second arbitrator. The arbitrators shall decide according to law and in observance of the adversarial principle; the award must be resolved on within a time-limit of 90 days starting from the date of acceptance of the last arbitrator. The arbitration will take place in Reggio Emilia.

13. COURT OF JURISDICTION AND GOVERNING LAW - For any dispute the Court of Reggio Emilia has exclusive jurisdiction and the governing law is exclusively Italian law.

14. EFFECTIVENESS OF EACH CONDITION - The above general conditions of sale must under no circumstances be understood merely as standard clauses. They are effective and faithfully represent the contractual intent of the parties.

15. GOODS RECEIVING - Upon receipt of the goods, the customer must check that the material is compliant with the contents of the transport document. Claims in respect of material delivered to the job site that does not correspond to the contents of the transport document will not be accepted. Gruppo Romani will cover the cost of transport and eventual replacement or supply of any material found to be non-compliant with the contents of the transport document. Any requests for goods to be returned due to order errors, customer waiver, or in any case for reasons not attributable to the company, will entitle us to apply a charge equal to 10% of the value of the returned goods.

CONDITIONS GENERALES DE VENTE

Condizioni generali di vendita . General terms of sale . Allgemeine Verkaufsbedingungen

1. DISPOSITIONS CONTRACTUELLES - Sauf modifications ou dérogations éventuelles convenues par écrit, les présentes conditions générales régissent tous les contrats de vente entre nous et l'acheteur, autrement dit tant le contrat conclu lors de l'acceptation de la présente commande que tout contrat futur relatif à la fourniture de produits de notre société demandés à l'occasion de commandes successives et distinctes.

2. FOURNITURES - Le prix indiqué ici s'entend hors frais de transport, TVA et éventuels droits de douane, pour des marchandises départ usine.

3. COMMANDES - L'acheteur s'engage à ne pas se rétracter de la proposition de commande faite au personnel commercial de notre société.

Les commandes sont toujours transmises par nos agents « SOUS RÉSERVE DE L'APPROBATION PAR NOTRE SOCIÉTÉ », avec la faculté d'accepter ou de modifier la commande. Les indications ci-dessus s'appliquent également en cas de cessions gratuites à des salles d'exposition. Avant de traiter les commandes, la société se réserve le droit de demander des informations commerciales.

4. LIVRAISONS - Les délais de livraison n'ont pas valeur contractuelle. L'inexécution d'une commande déjà confirmée ou un retard de livraison excluent toute responsabilité de notre part en cas de causes qui ne nous sont pas imputables, telles que des empêchements ou des difficultés de transport, des grèves, des lock-out, des impossibilités ou même des difficultés d'approvisionnement en temps utile en matières premières. L'acheteur ne peut donc en aucun cas demander la résiliation du contrat ou exiger une indemnité pour tout dommage direct ou indirect lié à un retard de livraison.

5. CHOIX - Le matériau livré sera conforme au type de choix commandé. Toutefois, les demandes de certains pourcentages de choix de produits spécifiques seront considérées comme de simples indications et satisfaites dans la mesure où les quantités produites le permettent.

6. TRANSPORT - La marchandise, même lorsqu'elle est vendue franco destination, voyage aux risques et périls de l'acheteur, notre responsabilité cessant au moment de la remise au transporteur. C'est pourquoi les réclamations pour tout matériau manquant ou abîmé devront être adressées exclusivement à celui-ci.

7. PRIX - Nous nous réservons le droit de modifier les prix de la présente liste de prix avec un préavis de 30 (trente) jours.

8. PAIEMENTS - Les paiements doivent parvenir au siège de notre société. L'acceptation d'effets ou de chèques déplacés ou le paiement, après accord, moyennant plusieurs traites, ne déroge pas à cette condition. Les factures n'ayant pas fait l'objet d'une réclamation dans les 8 (huit) jours suivant leur réception s'entendent acceptées. Les paiements devront être effectués selon les modalités et dans les délais convenus dans le contrat de fourniture. En cas de retard de paiement des sommes qui nous sont dues, il nous appartient de suspendre les livraisons et d'annuler les contrats en cours. Les intérêts liés aux retards de paiement devront être expressément convenus suivant des taux à définir. À défaut, les intérêts moratoires légaux s'appliqueront.

9. RÉCLAMATIONS POUR VICES - Toute réclamation pour vices apparents ou cachés de la marchandise faisant l'objet de la fourniture doit être adressée à notre siège par lettre recommandée avec accusé de réception dans un délai maximum de 8 (huit) jours après réception de la marchandise. En tout état de cause, avant de procéder à la pose du matériau céramique vendu, il incombe à l'acheteur et/ou au client final, auquel cette obligation devra être contractuellement étendue, de vérifier l'existence ou non de vices et/ou de défauts apparents afin de ne pas aggraver le préjudice. Toute réclamation concernant le matériau déjà posé sera par conséquent rejetée. La pose du matériau entraîne la renonciation à la garantie pour vices apparents de la marchandise fournie et complète les dispositions de l'art. 1227 du Code civil italien. La garantie est expressément exclue pour les marchandises classées de deuxième ou troisième choix, les groupes de produits ou les lots occasionnels.

Les offres spéciales, transactions, crédits accordés par nos agents ou intermédiaires ne sont valables que s'ils sont confirmés par écrit par notre siège. Nos échantillons sont purement indicatifs et sont présentés par nos soins dans le seul but de fournir au client des indications générales sur le produit.

10. SOLVE ET REPETE - L'acheteur ne peut se prévaloir d'aucune exception, sauf celles de nullité, d'annulation et de résiliation du contrat, pour retarder ou éviter le paiement.

11. RÉSERVE DE PROPRIÉTÉ - La vente des marchandises inclut une clause de réserve de propriété, de sorte que les marchandises ne deviendront la propriété de l'acheteur qu'après le paiement intégral et effectif du prix. Le non-paiement ne serait-ce que d'un seul versement entraînera la résiliation du contrat, sans préjudice du droit au paiement immédiat de tous les versements, y compris ceux qui ne seraient pas encore arrivés à échéance, ou la restitution immédiate de la marchandise. Dans ce cas, les sommes versées resteront acquises au vendeur à titre d'indemnité.

12. CLAUSE COMPROMISSOIRE - Exception faite des litiges inhérents au paiement du prix et aux actions correspondantes exercées par voie d'injonction ou par voie judiciaire ordinaire, qui restent de la compétence de la juridiction italienne, tout autre litige en lien avec la conclusion et/ou l'exécution et/ou la résiliation et/ou l'interprétation du présent contrat sera soumis à un collège de trois arbitres, chaque partie en nommant un et le dernier étant nommé d'un commun accord ou, en cas de désaccord, par le Président de la C.C.I.A.A. de Reggio Emilia, à la demande de la partie la plus diligente. La partie souhaitant engager un arbitrage doit en informer l'autre partie par lettre recommandée contenant la nomination de son arbitre et son acceptation. L'autre partie devra nommer son propre arbitre dans un délai de 15 jours à compter de la date de réception de la lettre recommandée, en communiquant cette nomination et son acceptation dans le délai indiqué. À défaut, l'autre partie pourra demander au Président de la C.C.I.A.A. de Reggio Emilia de procéder à la nomination du second arbitre. Les arbitres trancheront conformément à la loi et au principe du contradictoire. La sentence devra être rendue dans un délai de 90 jours à compter de la date d'acceptation du dernier arbitre. L'arbitrage aura lieu à Reggio Emilia.

13. TRIBUNAL COMPÉTENT ET DROIT APPLICABLE - En cas de litige, le Tribunal de Reggio Emilia est seul compétent et le droit applicable est le droit italien.

14. EFFICACITÉ DE CHAQUE CONDITION - Les conditions générales de vente indiquées ci-dessus ne doivent en aucun cas être considérées comme des clauses de style. Elles sont effectives et constituent l'expression fidèle de la volonté commerciale des parties.

15. RÉCEPTION DES MARCHANDISES - À la réception des marchandises, le client est tenu de vérifier que le produit livré est conforme au contenu du bulletin de livraison. Aucune réclamation ne sera acceptée pour du matériau livré sur le chantier qui ne correspond pas à celui mentionné dans le bulletin de livraison. En cas de non-conformité avérée, Gruppo Romani prendra en charge les frais de transport pour le remplacement et/ou l'intégration de la quantité de produit non conforme. Pour toute demande de retour en raison d'erreurs de commande, de renonciation de la part du client ou pour toute autre raison non imputable à la société, une contribution de 10 % de la valeur de la marchandise retournée sera demandée au client.

ALLGEMEINE VERKAUFSBEDINGUNGEN

Condizioni generali di vendita . General terms of sale . Conditions generales de vente

1. VERTRAGSBEDINGUNGEN - Diese allgemeinen Bedingungen regeln mit Ausnahme eventuell schriftlich vereinbarter Änderungen oder Abweichungen alle Verkaufsverträge zwischen uns und dem Käufer, d.h. sowohl den abgeschlossenen Vertrag mit der Annahme der vorliegenden Bestellung, als auch jeden zukünftigen Vertrag, der sich auf die Lieferungen von Produkten unserer Gesellschaft bezieht, die an späteren Zeitpunkten mit gesonderten Aufträgen bestellt werden.

2. LIEFERUNGEN - Der hier aufgeführte Preis ist der Nettopreis ohne Transportkosten, Mehrwertsteuer und eventuelle Zollgebühren und gilt für Warenübergabe ab Produktionswerk.

3. BESTELLUNGEN - Der Auftraggeber verpflichtet sich, die Gültigkeit seines an das Vertriebspersonal unserer Gesellschaft erteilten Bestellvorschlages aufrecht zu erhalten. Jede von unseren Vertretern zugesandte Bestellungen wird immer „VORBEHALTLICH UNSERER ZUSTIMMUNG“ entgegengenommen, d.h. wir behalten uns vor, die Bestellung nicht anzunehmen oder sie zu ändern. Dies gilt auch für eventuelle kostenlose Abtretungen für Ausstellungsräume. Vor der Erledigung der Bestellungen behalten wir uns vor, geschäftliche Informationen einzuholen.

4. LIEFERUNGEN - Die Liefertermine sind nie verbindlich; die Nichterledigung einer bestätigten Bestellung oder ihre verspätete Ausführung schließt in jedem Fall unsere Verantwortung wegen nicht auf uns zurückzuführende Ursachen, wie Verhinderung oder Schwierigkeiten bei Transporten, Streiks, Arbeiteraussperrungen, nicht mögliche Beschaffung oder auch nur Schwierigkeiten bei der rechtzeitigen Beschaffung der Rohmaterialien, vollkommen aus.

5. SORTIERUNG - Das Material wird in den verfügbaren Sorten geliefert. Forderungen bestimmter Sortenanteile werden als einfache Hinweise entgegengenommen und je nach den Produktionsergebnissen erfüllt.

6. TRANSPORT - Die Waren werden auf Risiko und Gefahr des Auftraggebers verschickt, auch wenn sie frei Haus verkauft werden, und unsere Verantwortung endet bei der Übergabe an den Frachtführer. Deshalb sind Reklamationen für eventuelle Fehlmengen oder Brüche ausschließlich an die Frachtführer zu richten.

7. PREISE - Wir behalten uns das Recht vor, die Preise dieser Preisliste mit einem Vorbescheid von 30 (dreißig) Tagen zu ändern.

8. ZAHLUNGEN - Die Zahlungen müssen bei unserer Niederlassung eingehen. Unsere Entgegennahme auswärtig ausgestellter Wertpapiere oder Schecks bzw. sonst vereinbarte Bezahlungen mittels Tratte sind keine Abweichungen von dieser Bedingung. Rechnungen, die nicht innerhalb von 8 (acht) Tagen ab Empfang beanstandet werden, gelten als akzeptiert. Die Zahlungen müssen in der Art und Weise und an den Fälligkeiten erfolgen, die in unseren Aufträgen angegeben sind. Bei verspäteter Bezahlung uns schuldiger Beträge sind wir berechtigt, die Lieferungen einzustellen und die laufenden Geschäftsbeziehungen abzubrechen.

Der Prozentwert der Verzugszinsen ist ausdrücklich zu vereinbaren. Andernfalls werden die gesetzlichen Verzugszinsen berechnet.

9. MÄNGELANZEIGE - Eventuelle Beanstandungen aufgrund irgendwelcher sowohl erkennbarer als auch verborgener Fehler an den zum Lieferumfang gehörenden Waren sind per Einschreibebrief mit Empfangsbescheinigung innerhalb von 8 (acht) Tagen ab Wareingang an unsere Niederlassung zu senden. Der Käufer und/ der Endkunde ist in jedem Fall in die vertragliche Verpflichtung einzubinden, das erworbene keramische Material vor der Verlegung auf ggf. vorhandene erkennbare Fehler und/oder Mängel zu prüfen, um den Schaden nicht zu verschlimmern. Eventuelle Reklamationen für bereits verlegtes Material werden daher zurückgewiesen. Die Verlegung führt zum Verzicht auf die Garantie für erkennbare Fehler der gelieferten Waren und integriert in jedem Fall die Bestimmungen im Art. 1227 des ital. ZGB. Für Waren der zweiten und dritten Sorte, sowie für Blocklieferungen oder Sonderpartien ist die Garantie ausdrücklich ausgeschlossen. Angebote, Transaktionen und Vergütungen, die von unseren Vertretern oder von Vermittlern erteilt werden, sind nicht gültig, wenn sie nicht schriftlich von unserer Niederlassung bestätigt werden. Unsere Muster gelten nur richtungsweisend und werden von uns nur vorgelegt, um den Kunden generelle Produktangaben zu liefern.

10. KLAUSEL ‚SOLVE ET REPETE‘ - Keine Einwände, ausgenommen die Nichtigkeit, Annullierbarkeit und Rückgängigmachung des Vertrags, können vom Käufer erhoben werden, um die Zahlung zu verzögern oder zu vermeiden.

11. EIGENTUMSVORBEHALT - Der Warenverkauf erfolgt mit der Eigentumsvorbehaltsklausel, d.h. das Eigentum der Waren geht erst auf den Käufer über, nachdem der Preis vollständig und effektiv bezahlt wurde. Die Nichtbezahlung auch nur einer Rate führt zur Vertragsauflösung mit Berechtigung zur Forderung der sofortigen Bezahlung aller auch noch nicht fälligen Raten oder der sofortigen Rückerstattung der Waren. In diesem Fall werden die bezahlten Beträge vom Verkäufer als Entschädigung einbehalten.

12. SCHIEDSKLAUSEL - Mit Ausnahme der Streitigkeiten in Bezug auf die Zahlung des Preises und der entsprechend getroffenen Maßnahmen zur Mahnung oder im ordentlichen Verfahren, für welche die italienische Gerichtsbehörde zuständig ist, wird jede sonstige Streitigkeit, die sich aus dem Abschluss und/oder aus der Ausführung und/oder Auflösung und/oder Auslegung des vorliegenden Vertrages ergeben sollte, einem Schiedskollegium mit drei Schiedsrichtern anvertraut, von denen zwei von jeweils einer der Parteien ernannt werden und der dritte Schiedsrichter in beiderseitigem Einverständnis, oder bei Uneinigkeit vom Vorsitzenden der Handels-, Industrie-, Handwerks- und Landwirtschaftskammer in Reggio Emilia nach Beantragung durch die sorgfältigere Partei. Die Partei, die das Schiedsgericht einzuschalten beabsichtigt, muss die andere Partei per Einschreibebrief davon in Kenntnis setzen und darin den von ihr ernannten Schiedsrichter und dessen Annahmeerklärung bekannt geben. Die andere Partei muss ihren Schiedsrichter innerhalb von 15 Tagen ab Empfang des Einschreibebriefes ernennen und diese Ernennung mit dazugehöriger Annahmeerklärung innerhalb der angegebenen Frist mitteilen. Andernfalls kann die andere Partei die Ernennung des zweiten Schiedsrichters beim Vorsitzenden der Handels-, Industrie-, Handwerks- und Landwirtschaftskammer in Reggio Emilia beantragen. Die Schiedsrichter entscheiden laut Gesetz und unter Einhaltung des Verhandlungsgrundsatzes; der Schiedsspruch ist innerhalb von 90 Tagen ab dem Datum der Annahmeerklärung des letzten Schiedsrichters zu beschließen. Der Sitz des Schiedsgerichts wird in Reggio Emilia sein.

13. GERICHTSSTAND UND ANWENDBARES RECHT - Für alle Streitigkeiten ist ausschließlich der Gerichtsstand Reggio Emilia zuständig und allein das italienische Recht ist anwendbar.

14. WIRKSAMKEIT JEDER BEDINGUNG - Die oben aufgeführten allgemeinen Verkaufsbedingungen dürfen keinesfalls als reine Stilklauseln betrachtet werden. Sie sind wirksam und entsprechen getreu dem rechtsgeschäftlichen Willen der Parteien.

15. WARENEMPFANG - Nach Erhalt der Ware verpflichtet sich der Kunde, die gelieferte Ware zu kontrollieren, insbesondere die Übereinstimmung mit den Angaben im Lieferschein. Für auf die Baustelle geliefertes Material, das den Angaben des Lieferscheins nicht entspricht, wird keine Reklamation akzeptiert. Wenn die gelieferte Ware den Angaben im Lieferschein nicht entspricht, wird Gruppo Romani die Transportkosten für die eventuelle Auswechslung/ Ergänzung der nicht konformen Produktmenge übernehmen. Für jede Forderung auf Rückerstattung auf Grund von Beststellungsfehlern, Verzicht durch den Kunden oder aus nicht dem Unternehmen zuzuschreibenden Gründen, wird eine Kostenbeteiligung von 10% des Werts der rückerstatteten Ware verlangt.

LISTINO PREZZI

Price List . Tarif . Preisliste



Tutti i formati sono nominali.
All sizes are nominal.

Condizioni generali di vendita, consigli di posa e pulizia sul sito web, www.cir.it
General terms of sale, laying and cleaning suggestion on website www.cir.it

Cir si riserva la facoltà di modificare in qualunque momento le informazioni e le caratteristiche illustrate nel presente catalogo, che non sono comunque da ritenere legalmente vincolanti. I colori e le caratteristiche estetiche dei prodotti sono quanto più possibile vicini a quelli reali, nei limiti consentiti dai processi di stampa. Pesì e misure possono subire variazioni tipiche del particolare processo di cottura del materiale ceramico.

Cir reserves the right to modify the information and the characteristics illustrated in this catalogue (which are in any case not legally binding) at any moment. The colours and appearance features of the products are as close as possible to reality, within the limitation of the printing process. Weights and dimensions are subject to the normal variations resulting from the ceramic firing process.

© Copyright 2024 Gruppo Romani S.p.A. Industrie Ceramiche: tutti i diritti riservati. Ogni riproduzione totale o parziale dei contenuti di questo catalogo, sia di testo sia di immagine, è vietata e sarà perseguita a termini di legge.

© Copyright 2024 Gruppo Romani S.p.A. Industrie Ceramiche: all rights reserved. Total or partial reproduction of text or illustration of this catalogue is prohibited and is subject to legal sanction.

Fasce di prezzo Price ranges Grupes des prix Preisgruppen	1° Scelta Mq 1st Choice Sqm 1 Choix Mc 1 Wahl Qm
A8	€ 58,00
A10	€ 60,00
A11	€ 62,00
A13	€ 64,00
A15	€ 66,00
A17	€ 68,00
A19	€ 70,00
A20A	€ 72,00
A22	€ 74,00
A22A	€ 75,00
A23	€ 76,00
A26	€ 75,00
A26A	€ 80,00
A28	€ 82,00
A29	€ 84,00
A31	€ 86,00
A35	€ 90,00
A36	€ 92,00
A36B	€ 94,00
A38	€ 96,00
A42	€ 100,00

Fasce di prezzo Price ranges Grupes des prix Preisgruppen	1° Scelta Pz 1st Choice Piece 1 Choix Unite 1 Wahl Stück
B2	€ 3,00
B3	€ 4,00
B4	€ 6,00
B5	€ 7,00
B8	€ 12,00
B9	€ 13,00
B10	€ 14,00
B11	€ 15,00
B12	€ 16,00
B13	€ 17,00
B14	€ 18,00
B15	€ 19,00
B16	€ 20,00
B18	€ 22,00
B19	€ 23,00
B20	€ 24,00
B21	€ 25,00
B22	€ 26,00
B24	€ 28,00
B32	€ 40,00
B35	€ 47,00
B36	€ 53,00
B37	€ 58,00
B45	€ 86,00
B52	€ 106,00
B62C	€ 194,00
B62D	€ 204,00
B63	€ 215,00
B63B	€ 236,00
B67	€ 408,00
B68	€ 430,00
B68A	€ 440,00
B68C	€ 460,00
B72	€ 555,00

Fasce di prezzo Price ranges Grupes des prix Preisgruppen	1° Scelta ml 1st choice linear metre 1er choix ml 1. Wahl Lfm.
C3	€ 16,00
C5	€ 18,00
C6	€ 19,00

A
Prezzo al m²
Price x sqm
Prix / m²
Preis x qm

B
Prezzo al pezzo
Price per piece
Prix a l'unité
Preis pro Stück

C
Prezzo al m lineare
Price per linear metre
Prix au m linéaire
1. Wahl Lfm.

★
IL PREZZO DELLA SCELTA COMMERCIALE,
È DEL -50% DAL PREZZO DELLA 1A SCELTA.

FOR COMMERCIAL GRADE TILES, A
DISCOUNT OF 50% ON THE PRICE OF THE
1ST CHOICE TILES.

LE PRIX DU CHOIX COMMERCIAL, EST
DE -50 % PAR RAPPORT AU PRIX DU 1ER
CHOIX.

DER PREIS FÜR DIE HANDELSORTIERUNG
BETRÄGT, 50 % WENIGER ALS DER PREIS
FÜR DIE 1. WAHL.

TUTTI I DECORI E I BATTISCOPA SONO
VENDUTI A SCATOLE INTERE.
ALL DECORS AND BASEBOARDS ARE SOLD
IN FULL BOXES.
TOUS LES DÉCORS ET LES PLINTHES SONT
VENDUS PAR BOÎTES COMPLÈTES.
FORMTEILVERKAUF NUR KARTONSWEISE
MÖGLICH.

IVA E TRASPORTO ESCLUSI.
VAT AND TRANSPORT NOT INCLUDED.
TVA ET TRANSPORT NON INCLUS.
MWST UND TRANSPORT NICHT INBEGRIFFEN.

CE
GRUPPO ROMANI S.P.A. INDUSTRIE CERAMICHE VIA A. VOLTA 9, 23/25 42013 CASALGRANDE (RE)
05 001CPR2013-07-01
EN 14411:2012
Piastrelle di ceramica pressate a secco, con assorbimento di acqua E _s ≤ 0,5% per pavimentazioni interne ed esterne. Dry pressed ceramic tile, with water absorption E _s ≤ 0,5% for internal and external floorings.



© Copyright 2024 Gruppo Romani S.p.A. Industrie Ceramiche

Gruppo Romani S.p.A. Industrie Ceramiche
www.grupporomanispa.com

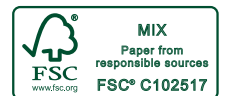

TILES FOR LIFE





www.cir.it



DAL 1967

CIR - MANIFATTURE CERAMICHE
www.cir.it

Via A. Volta 23/25 - 42013 Casalgrande (RE) Italy
Tel. +39-0522-998911

